

SMÅLANDS MUSEUM
VÄXJÖ

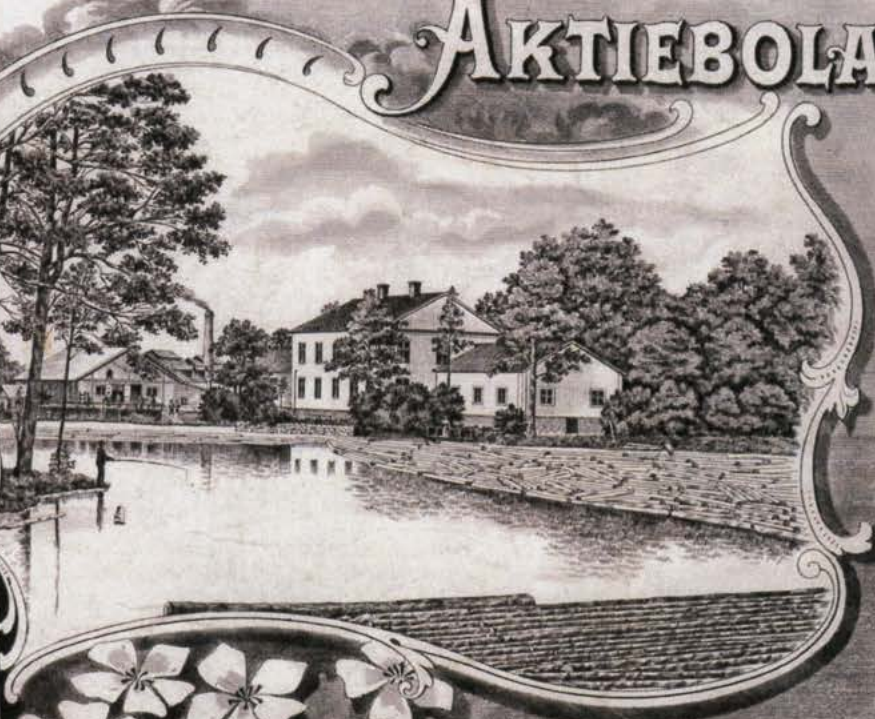

Illustrationer ÖFVER ÖRREFORS BRUKS- AKTIEBOLAGS

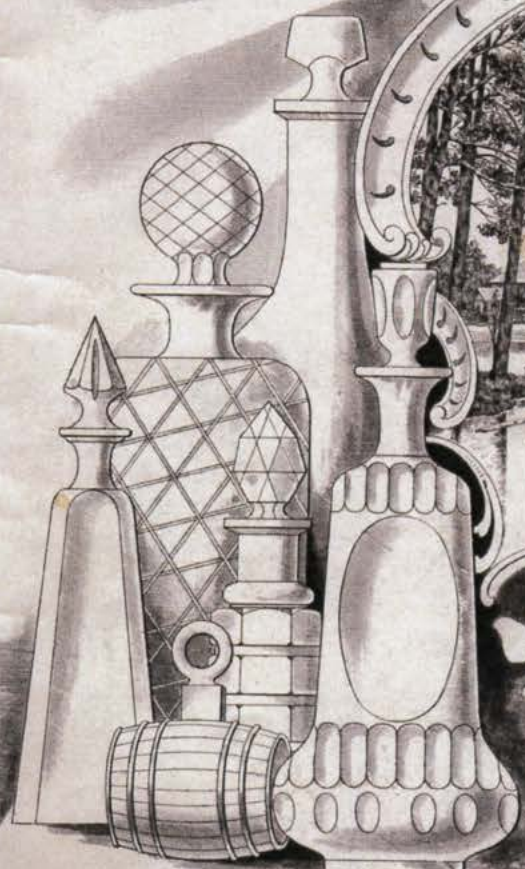

Tillverkningar
af
**PARFYMGLAS,
BLÄCKGLAS & FLASKOR M. M.**

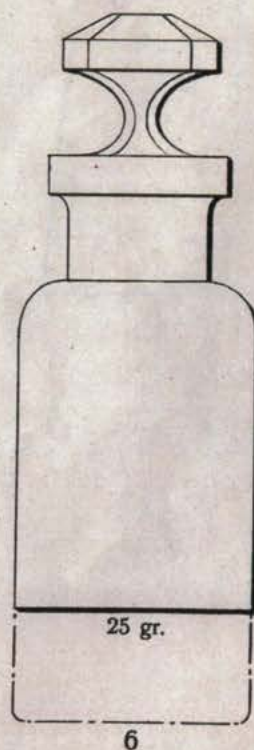
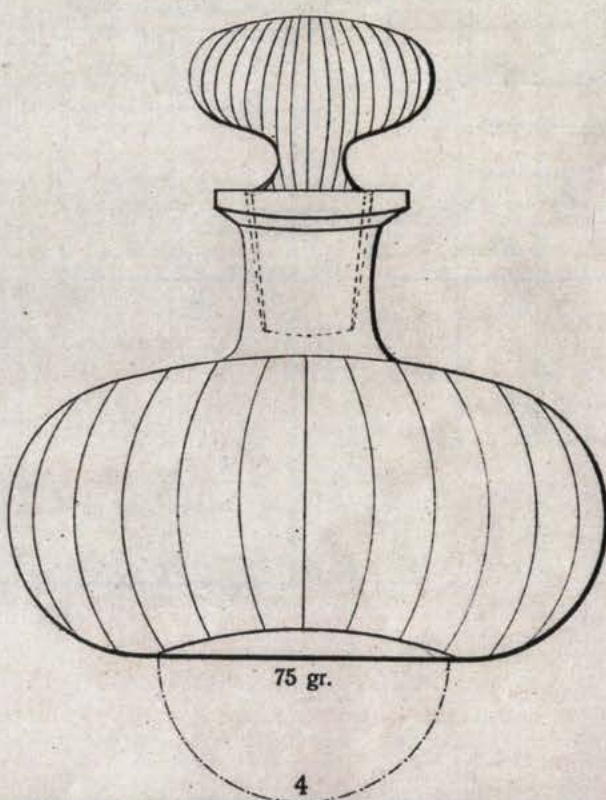
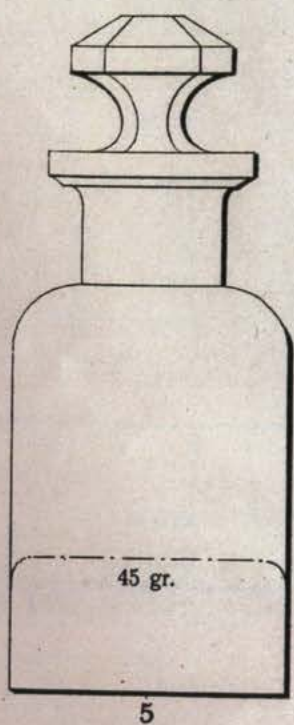
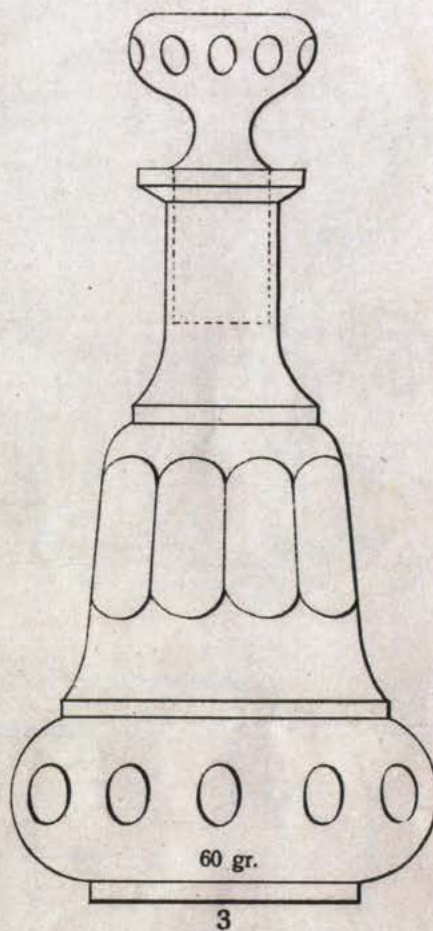
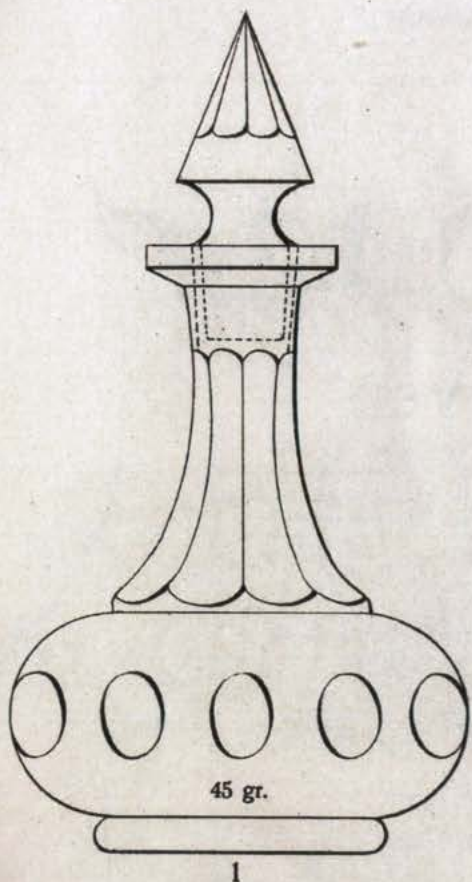

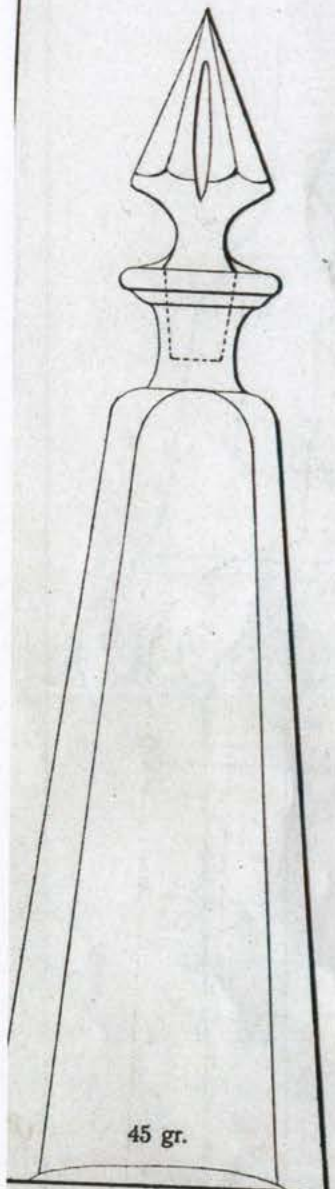

45 gr.

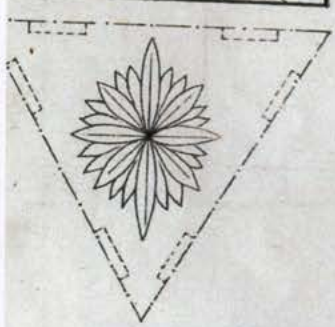

7

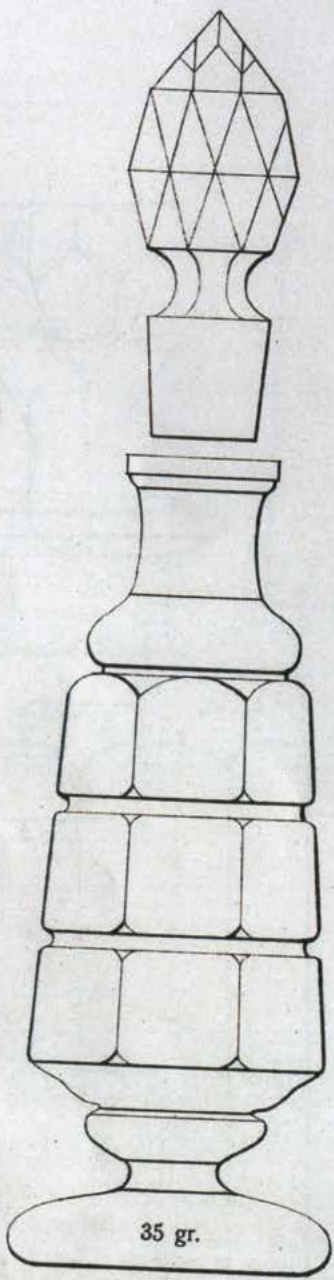

35 gr.

8

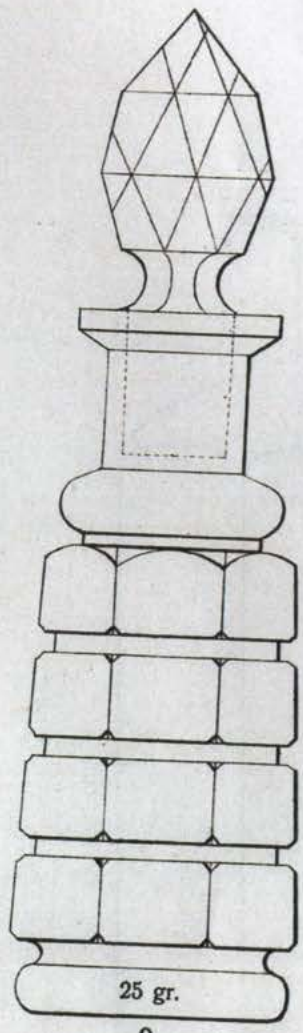

25 gr.

9

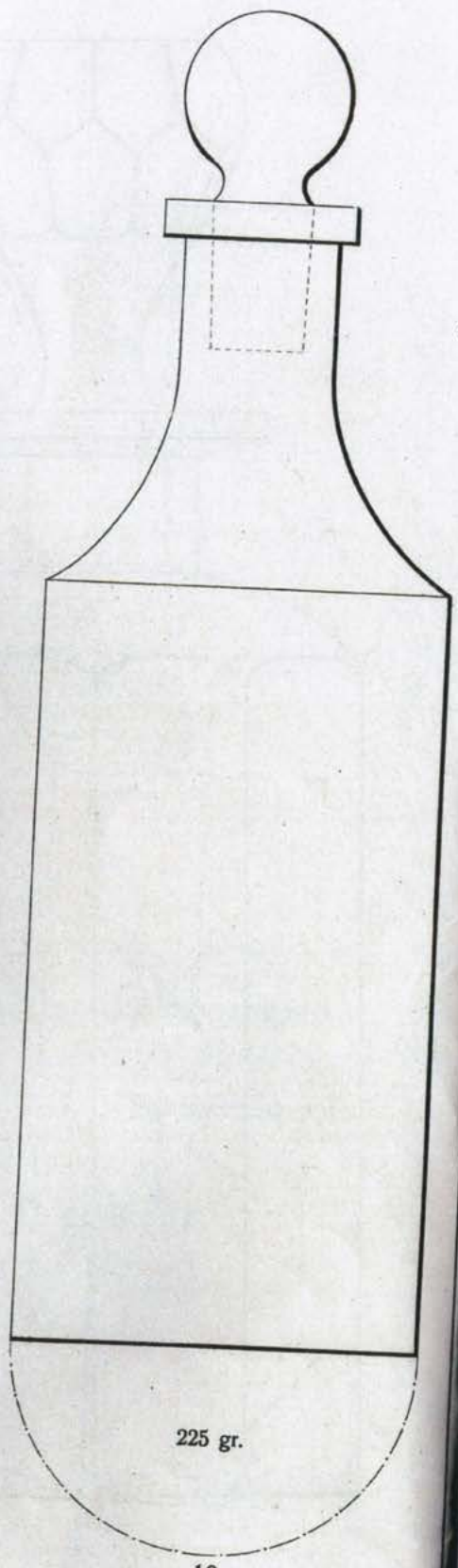

225 gr.

10

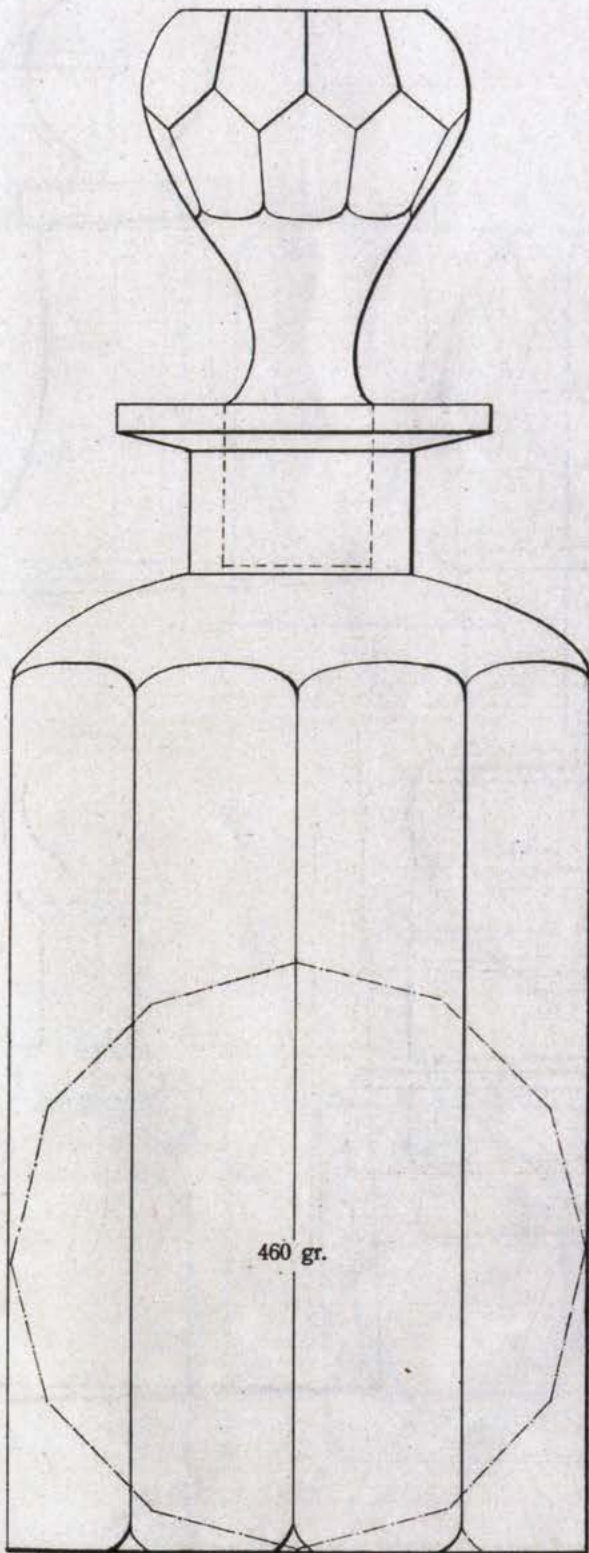

460 gr.

11

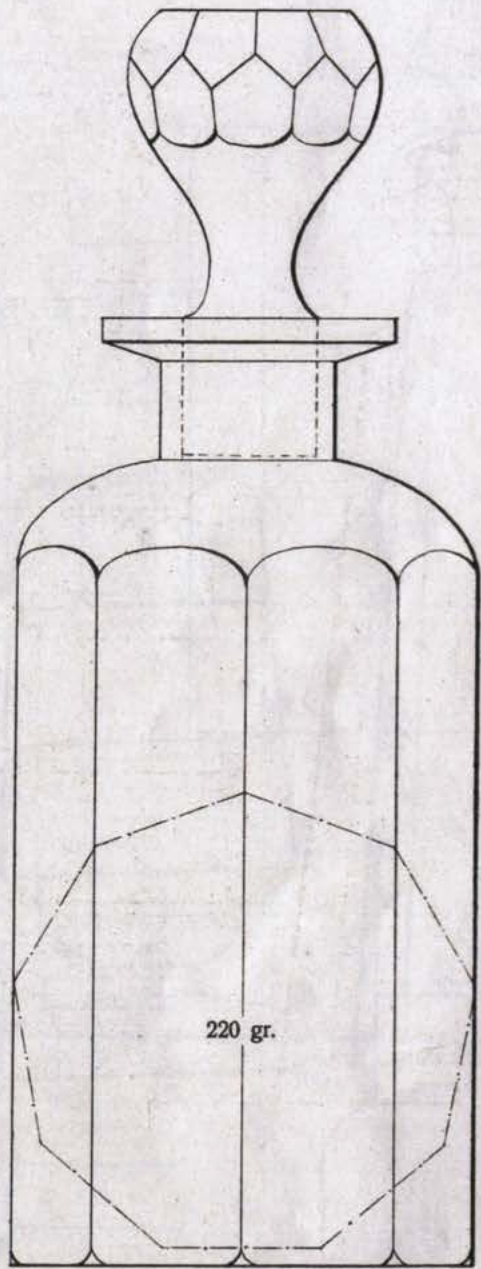

220 gr.

12

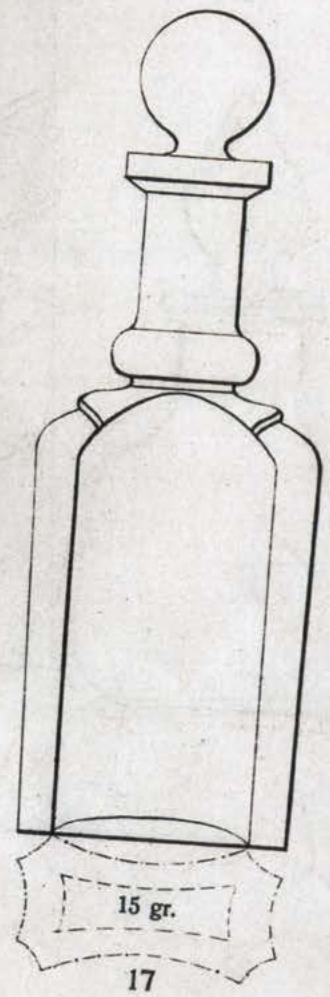
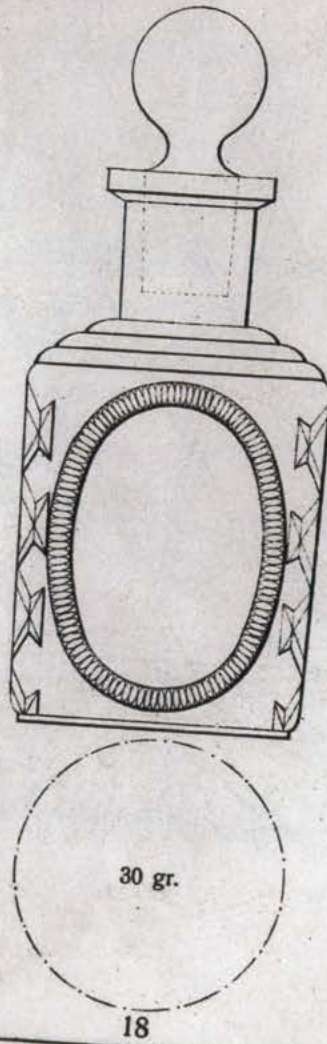
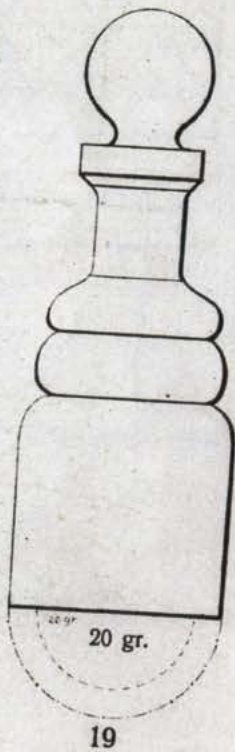
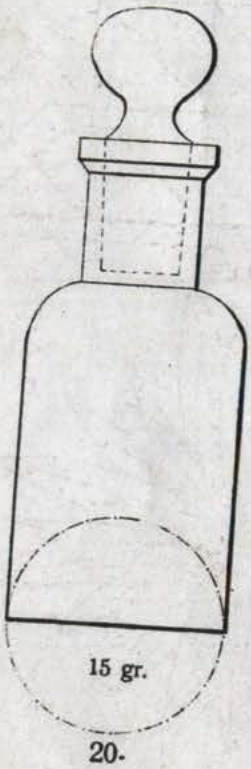
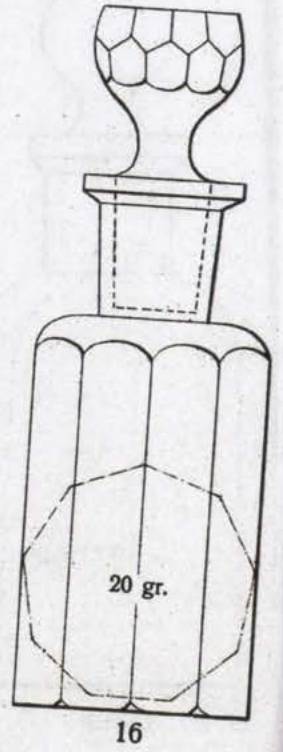
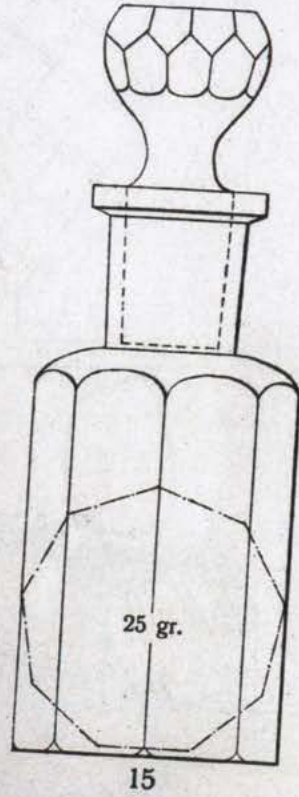
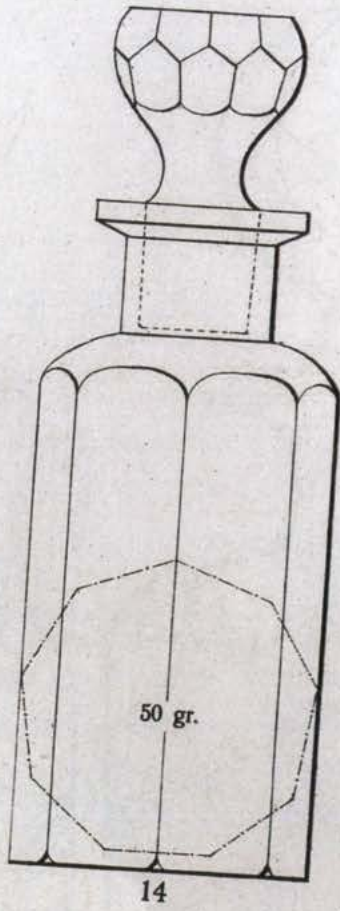
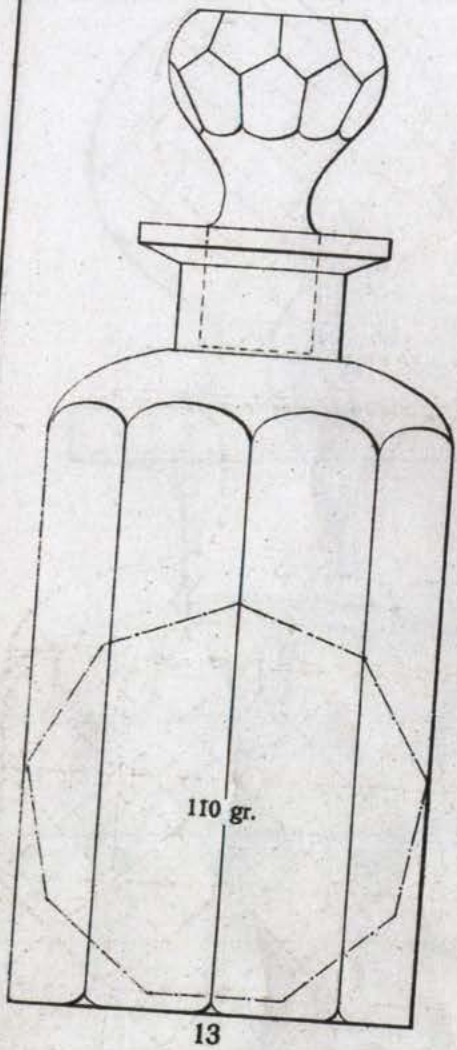

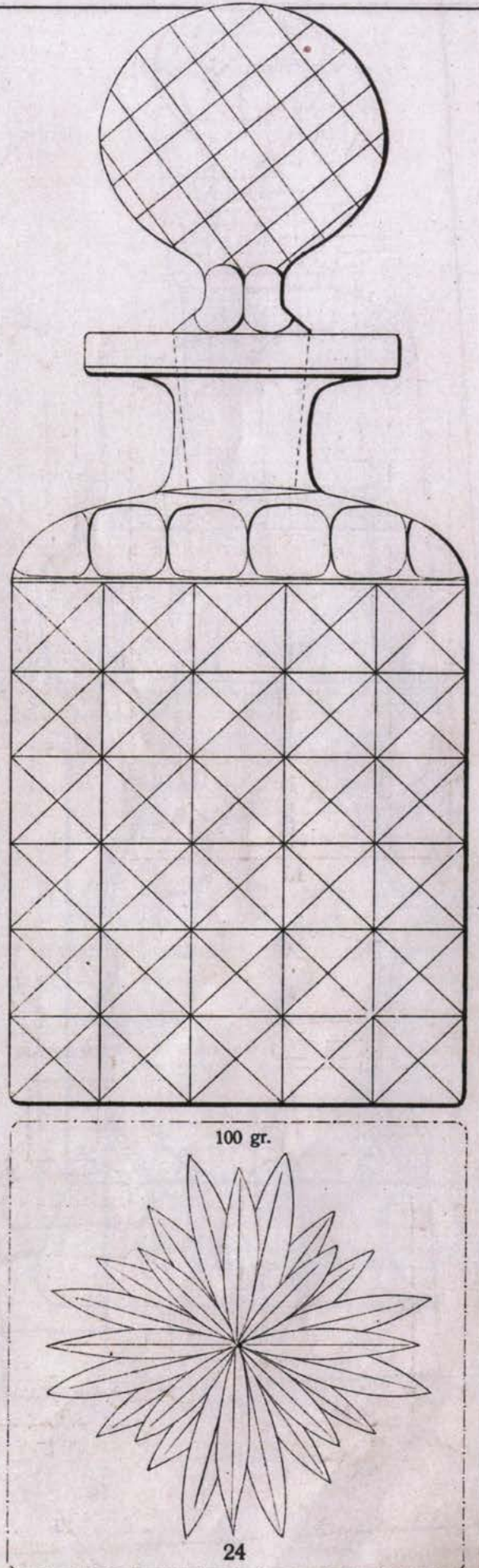
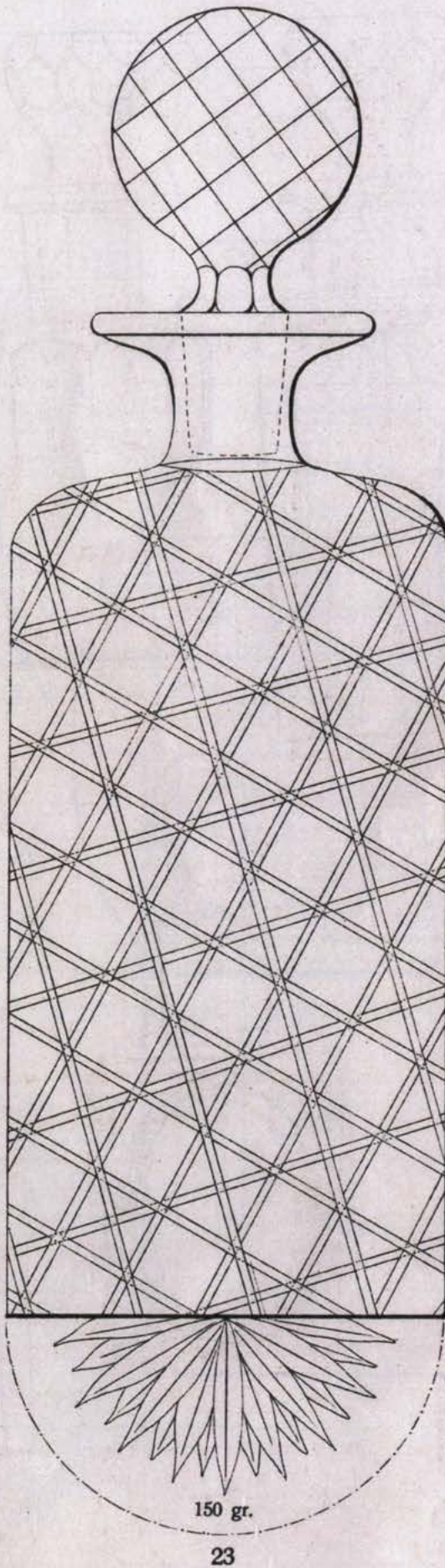
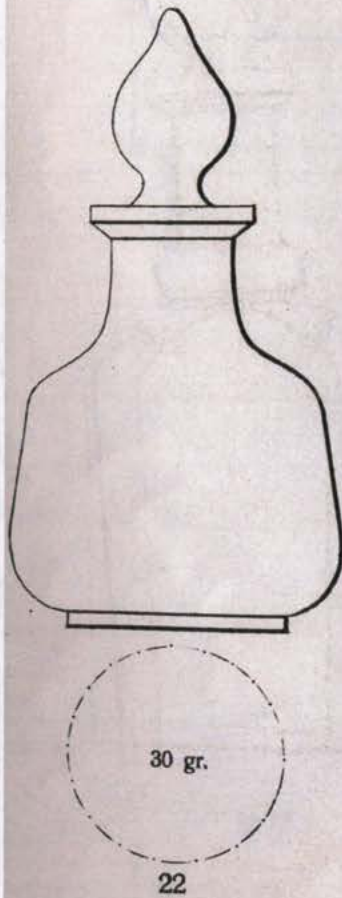
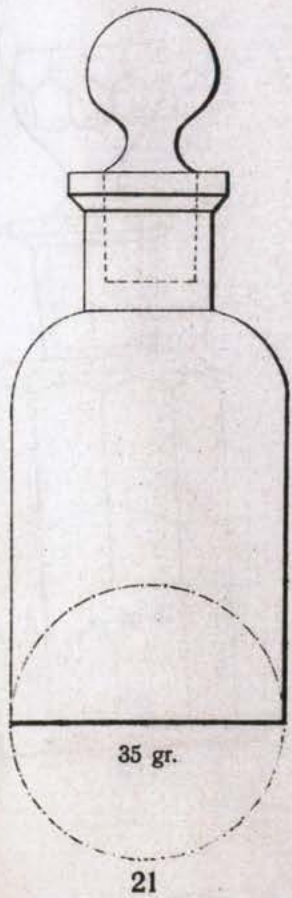

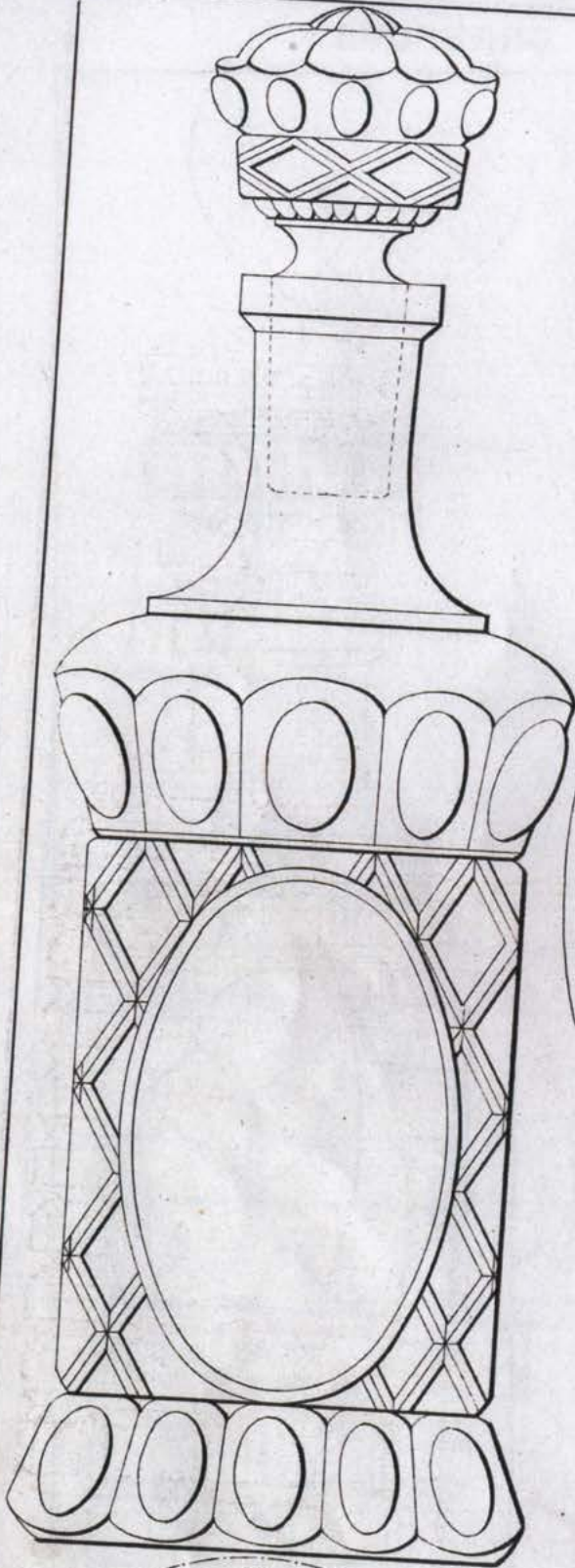

25

200 gr.

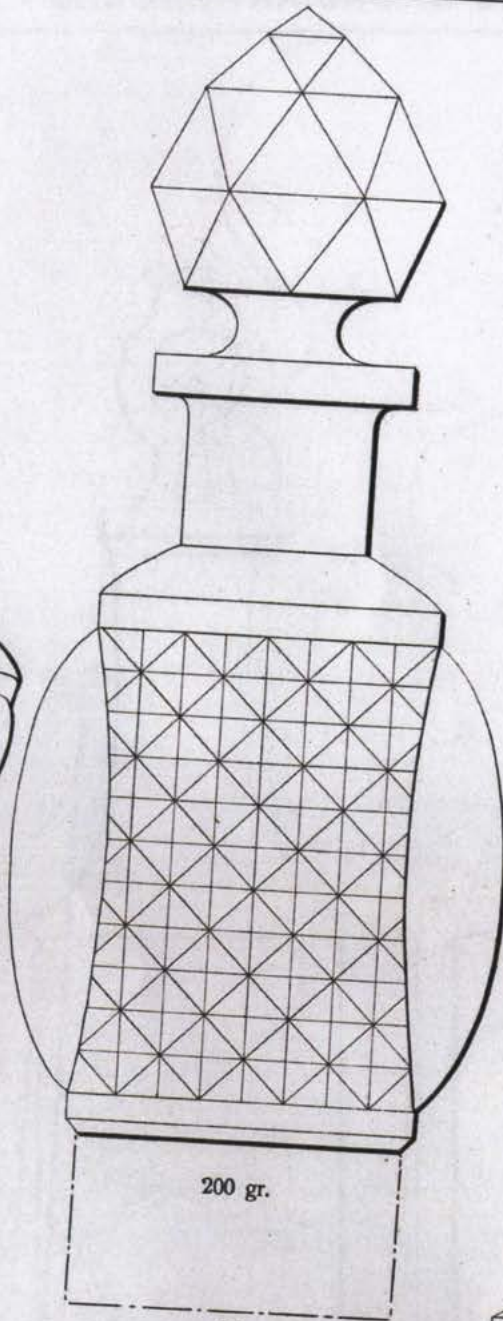

200 gr.

26

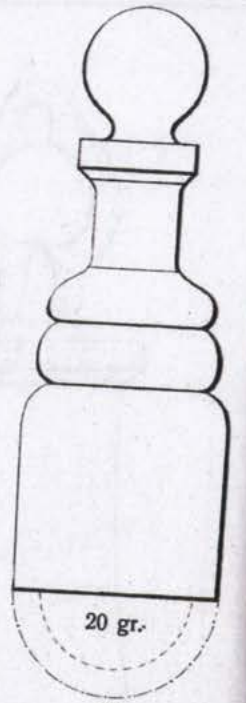

20 gr.

28

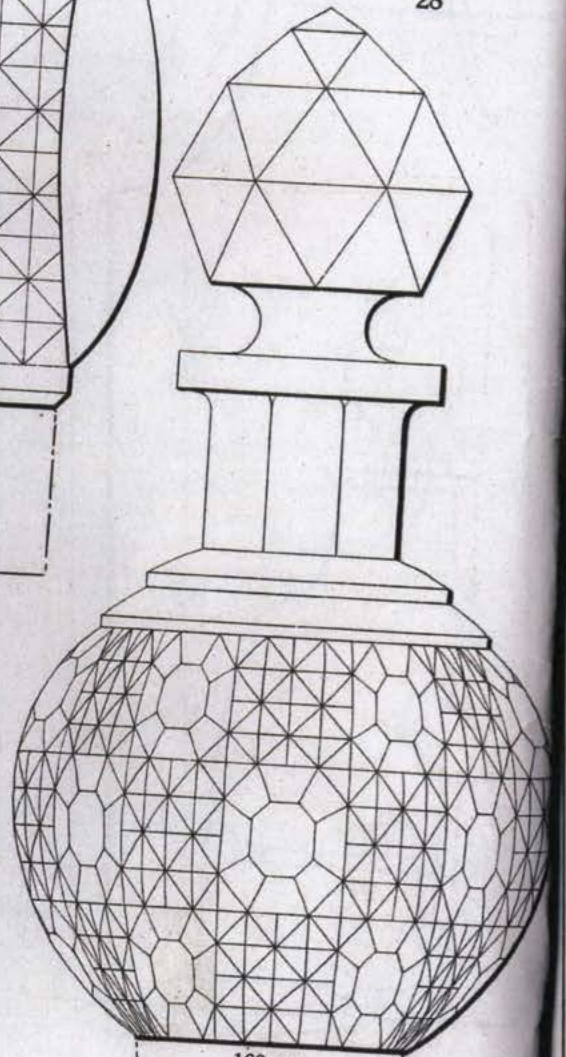

160 gr.

27

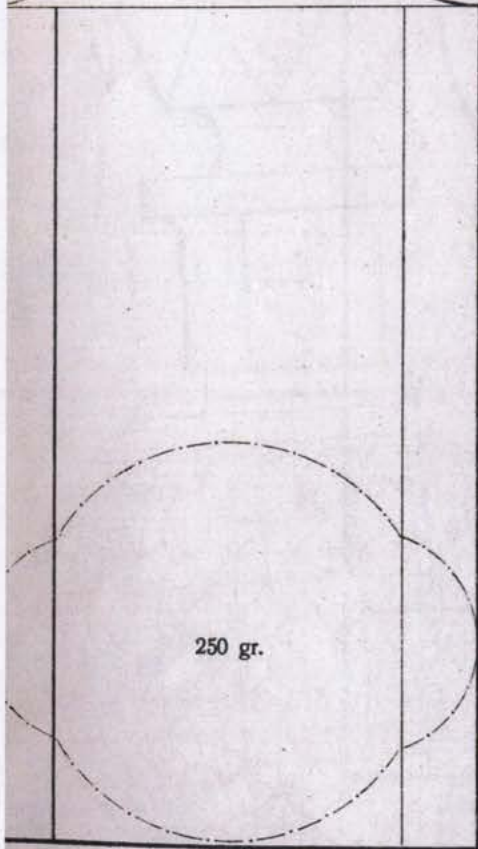
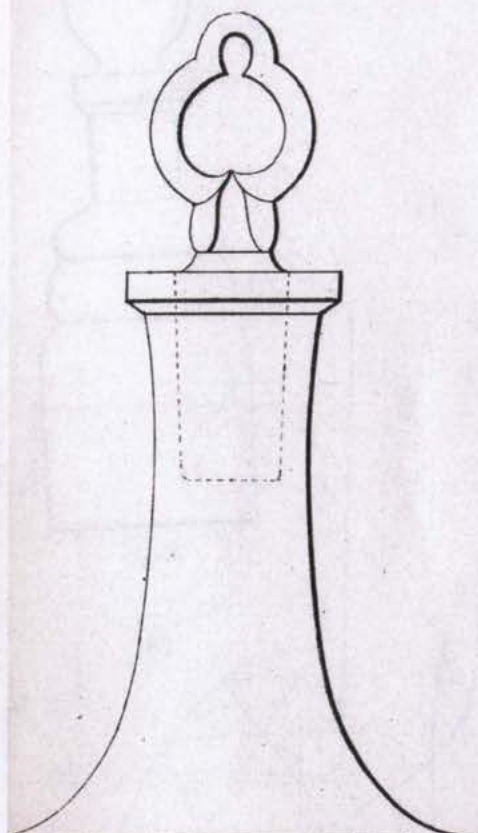

250 gr.

29

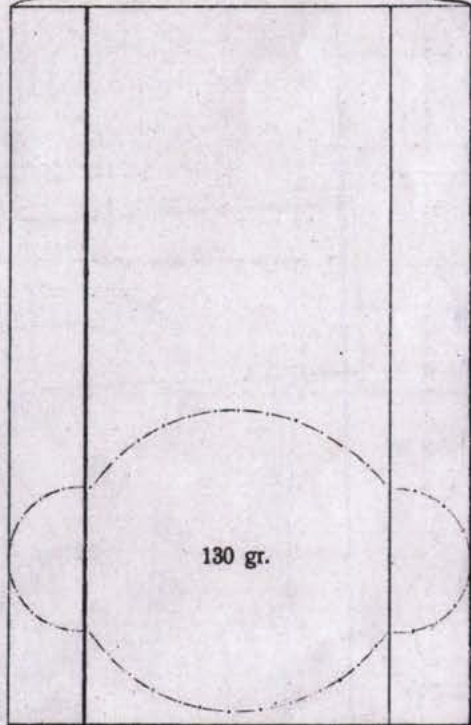
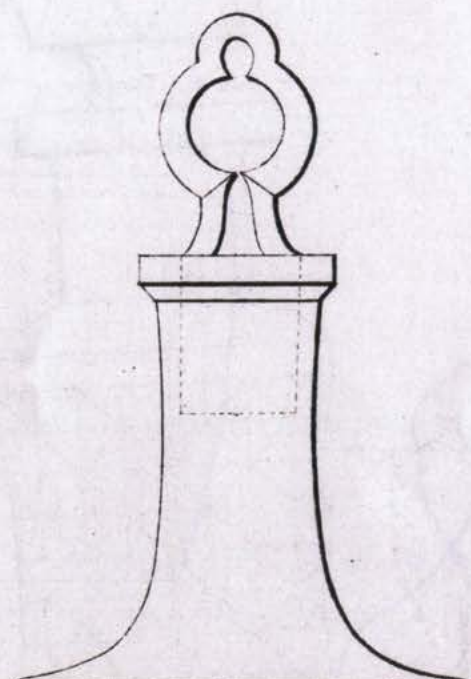

130 gr.

30

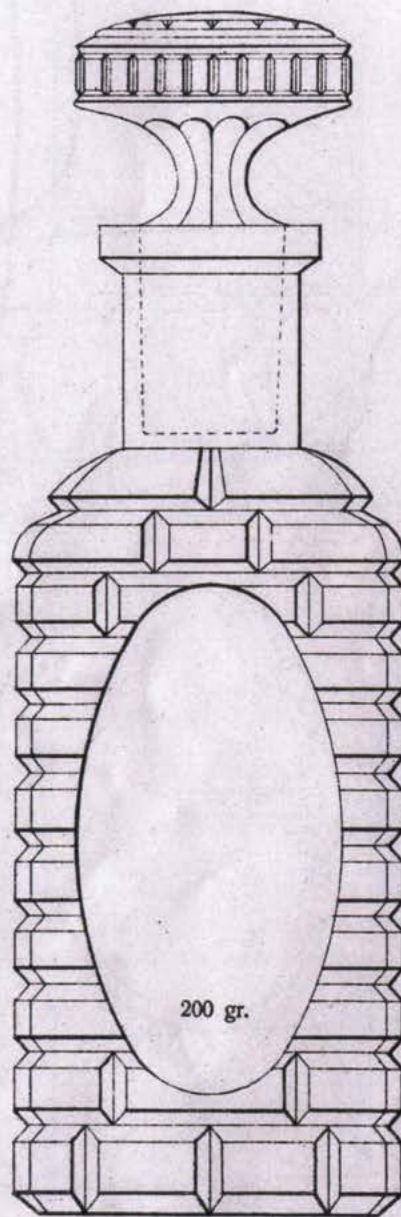

200 gr.

31

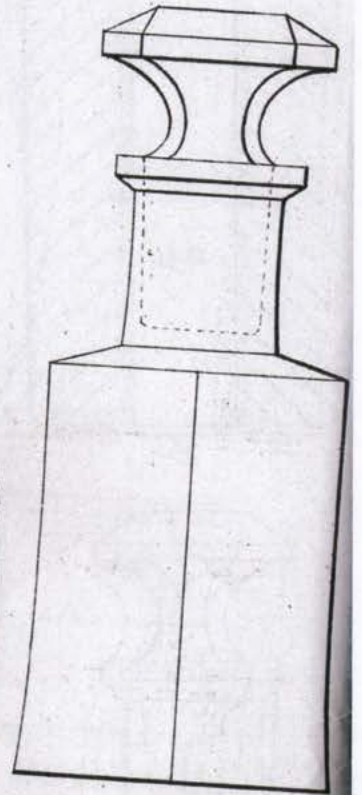
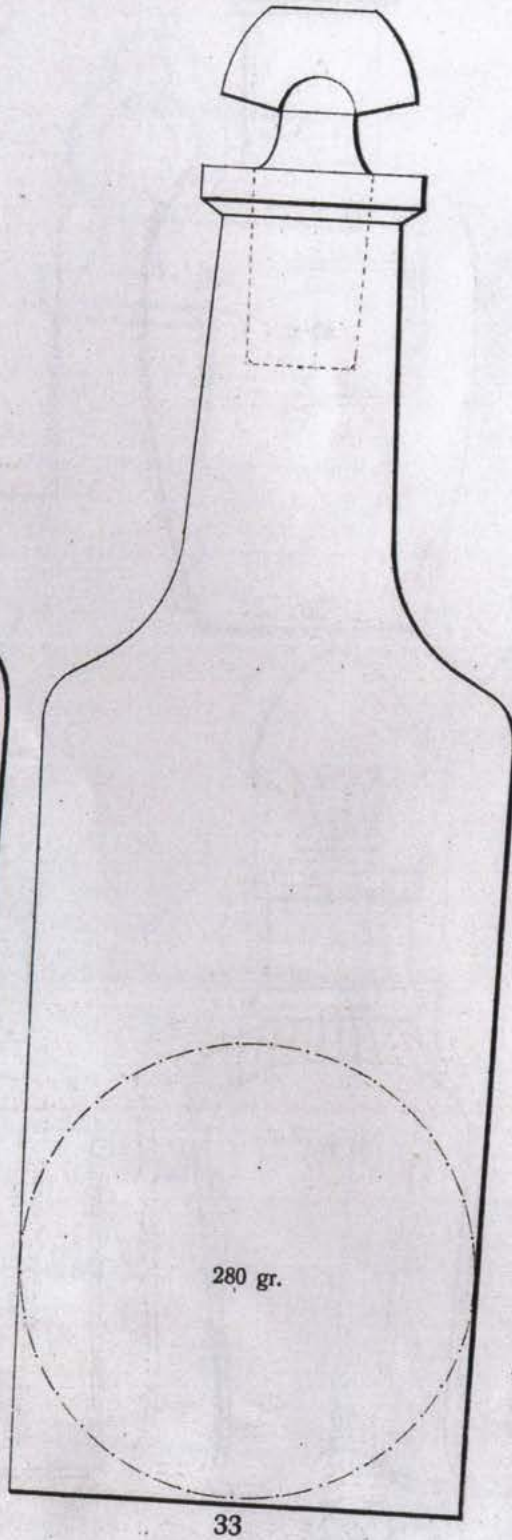
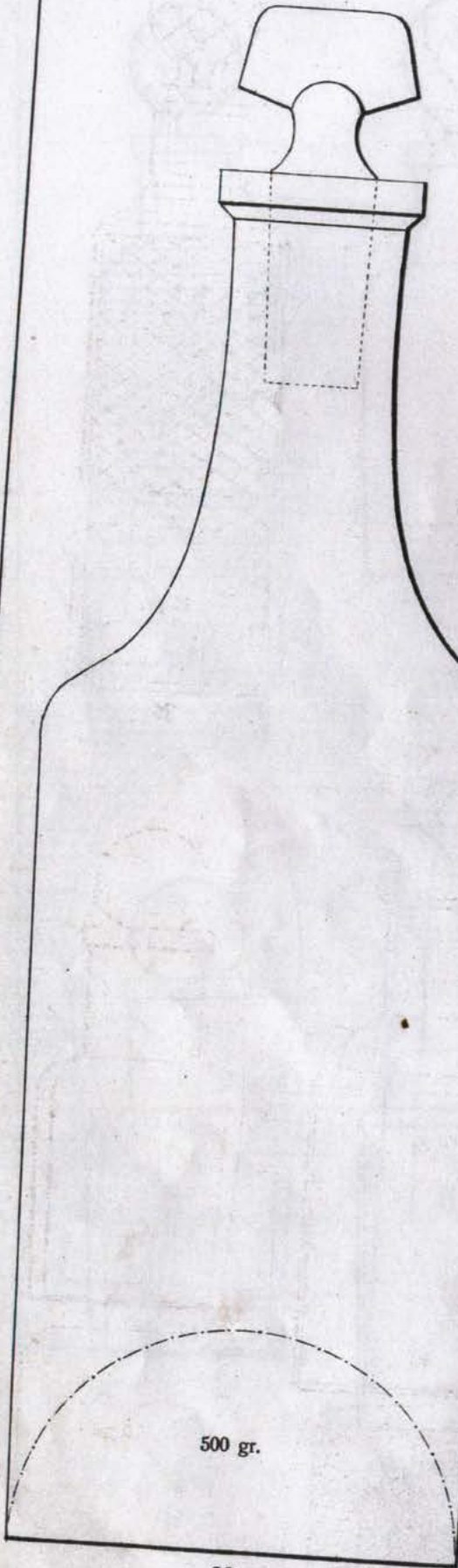

32

33

34

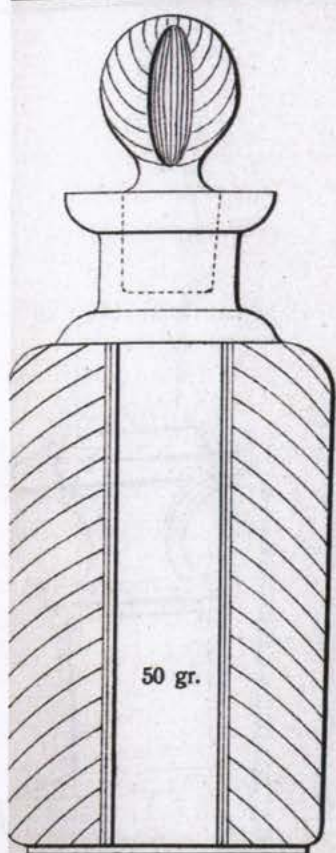

35

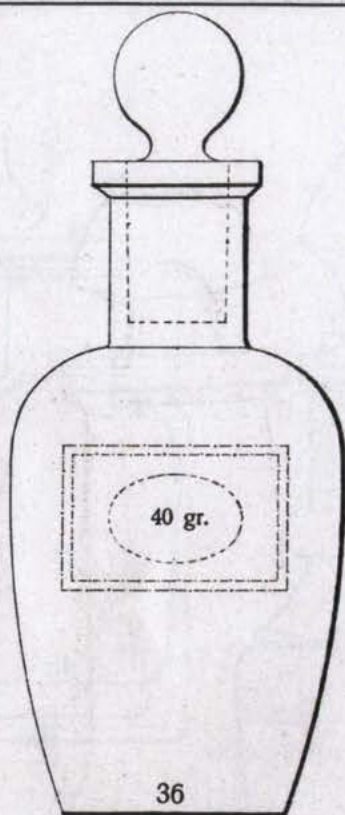

36

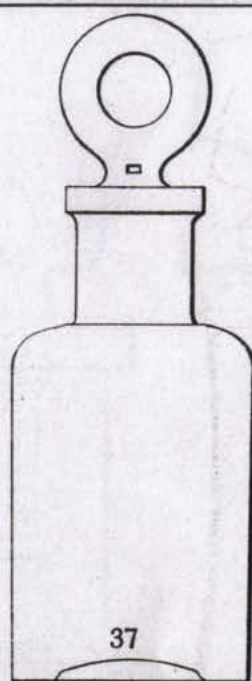

37



25 gr.

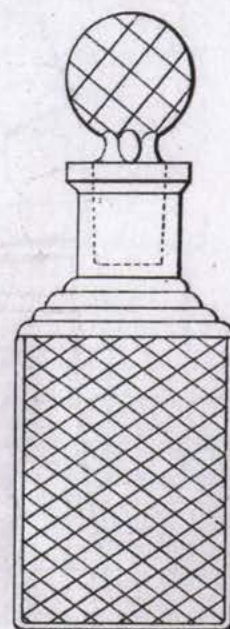

10 gr.



38

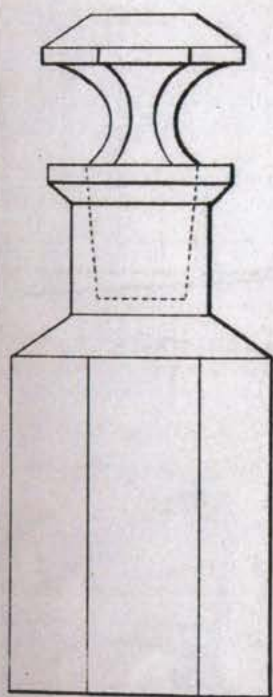

25 gr.

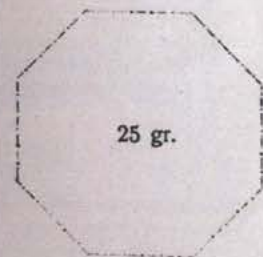

39

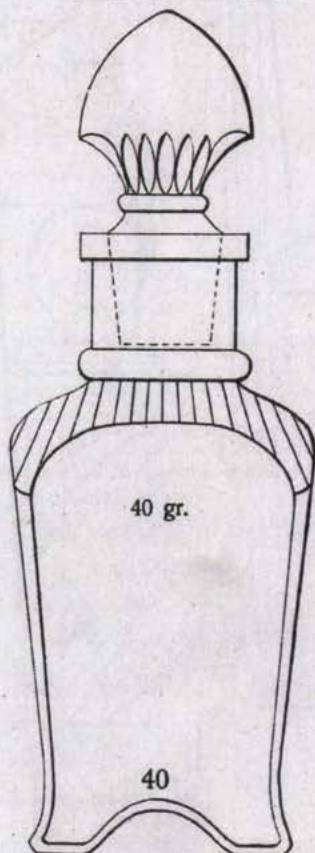

40 gr.

40

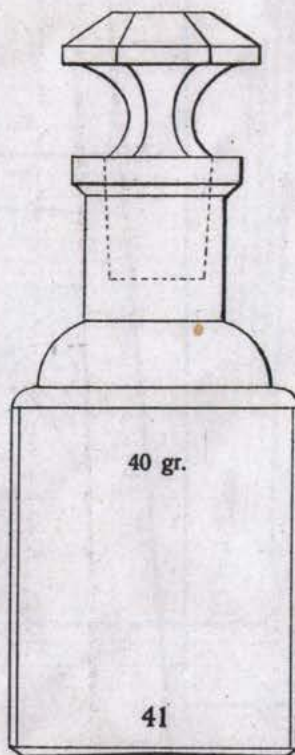
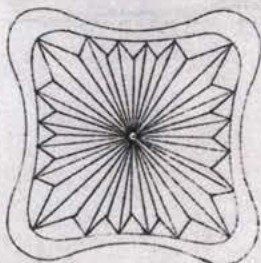

40 gr.

41

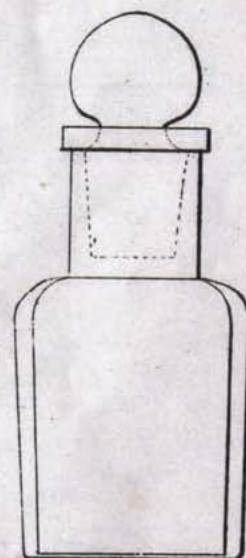
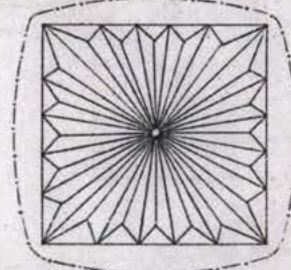

10 gr.



42

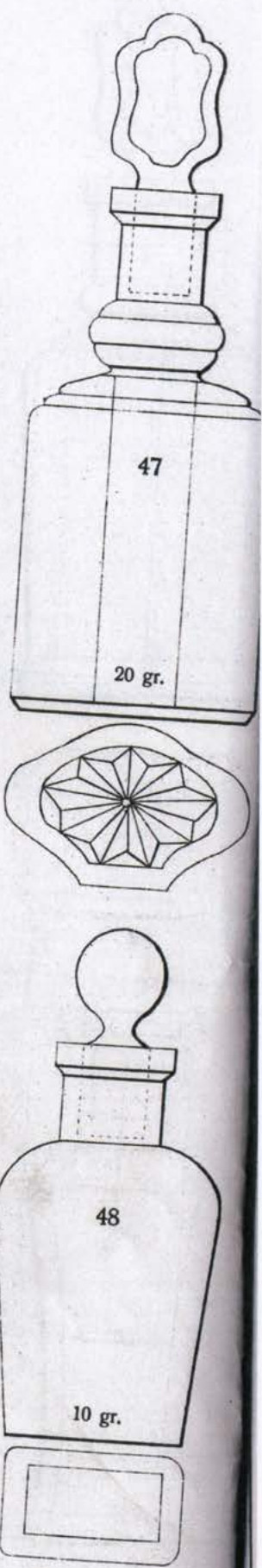
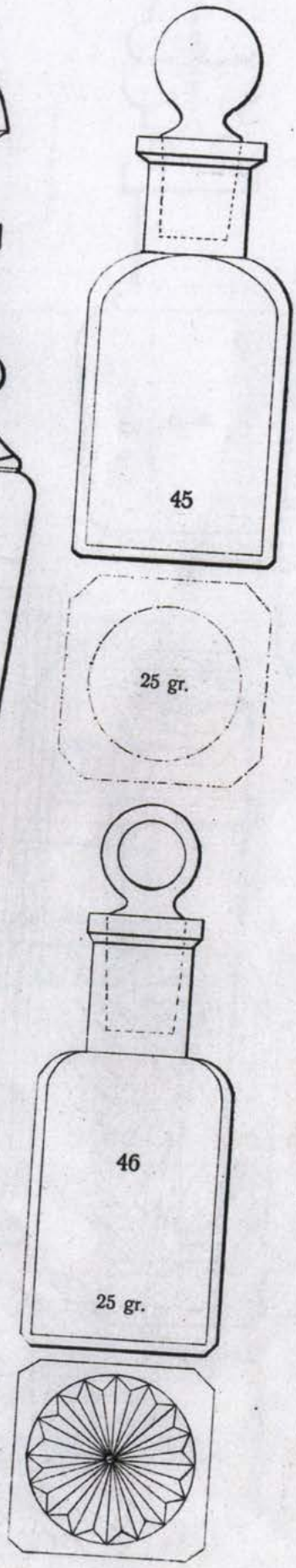
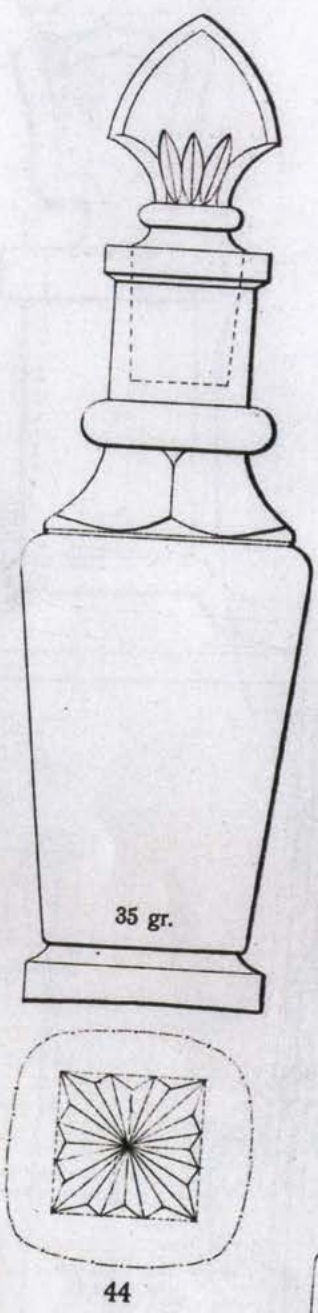
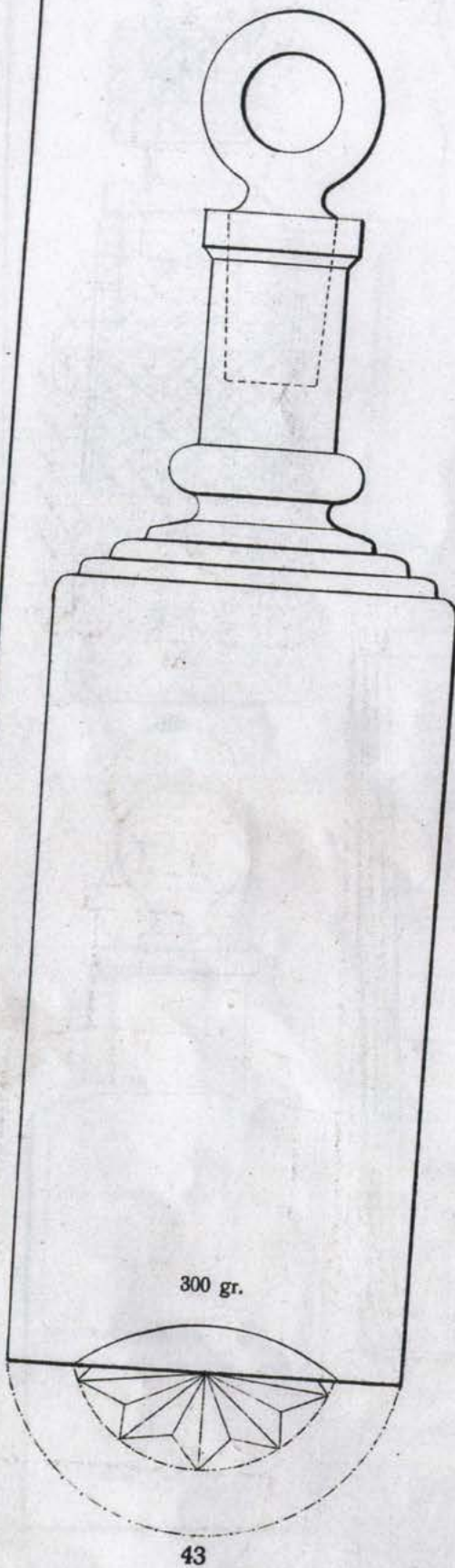

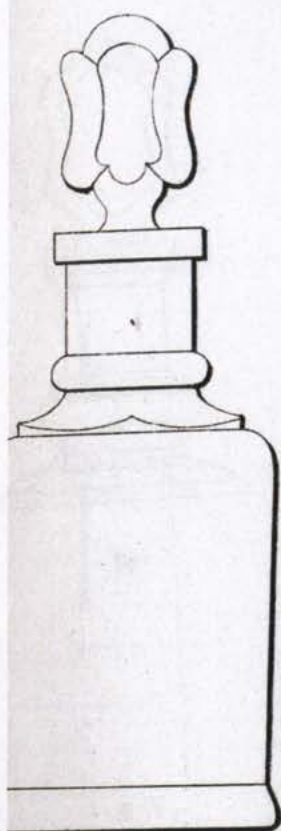

30 gr.

51

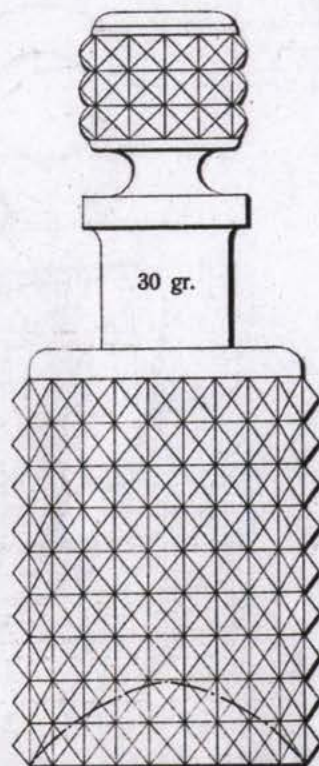
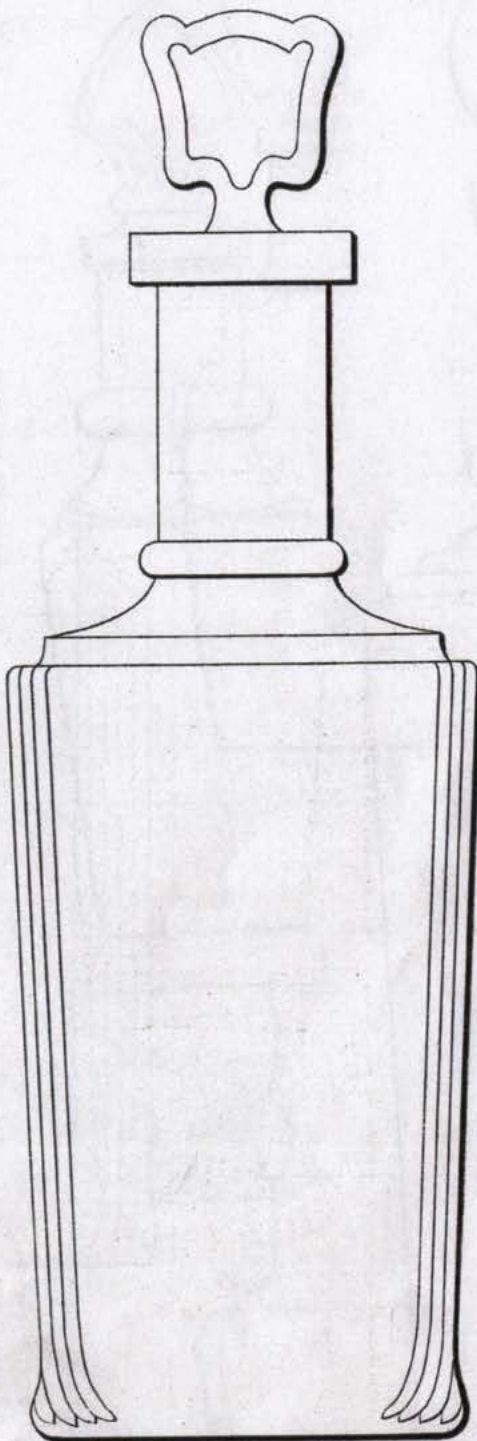

30 gr.

53

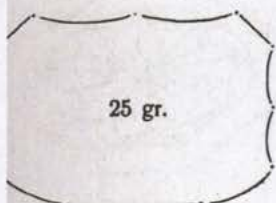

25 gr.

49

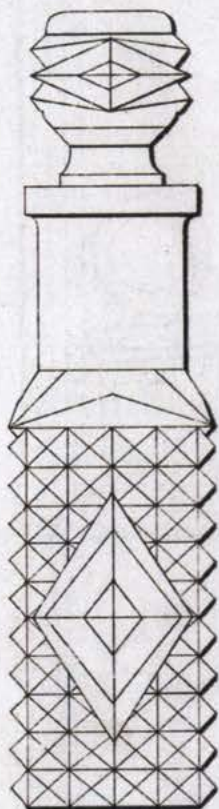

25 gr.

54

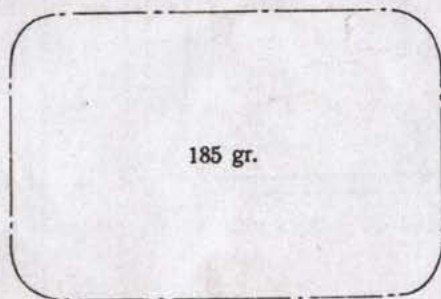

185 gr.

52

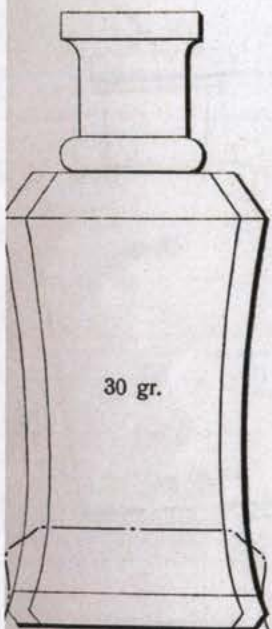

30 gr.

50

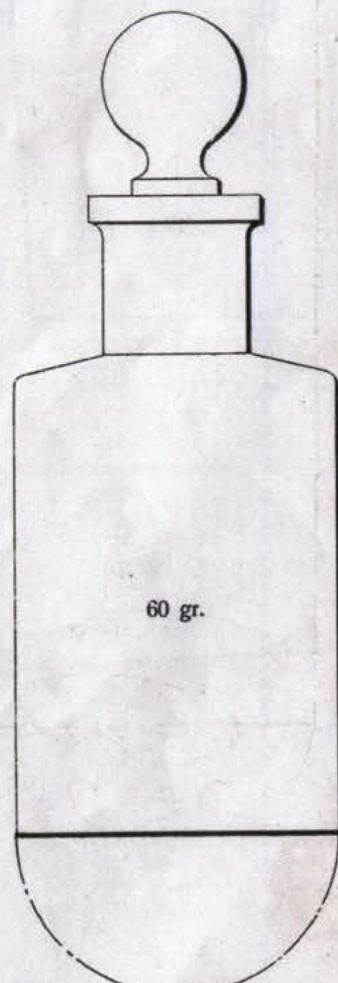

60 gr.

55

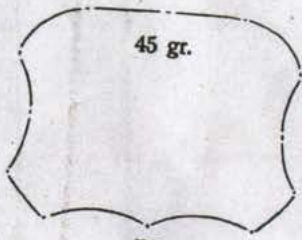
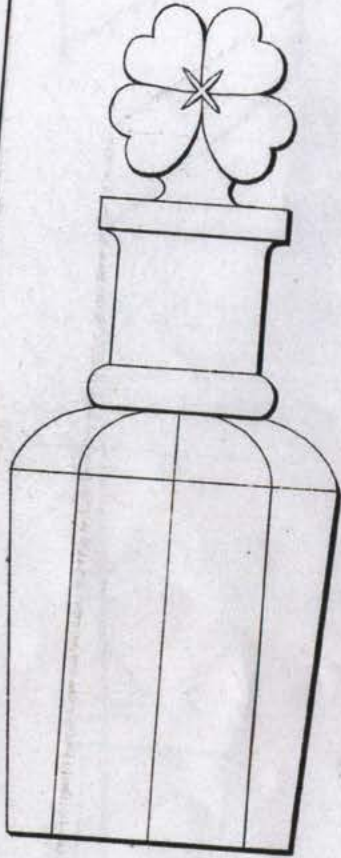

45 gr.

56

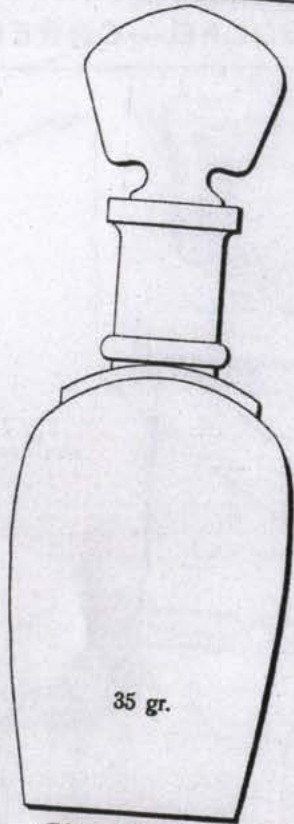

35 gr.

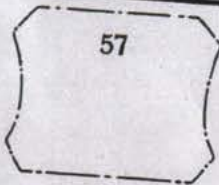

57

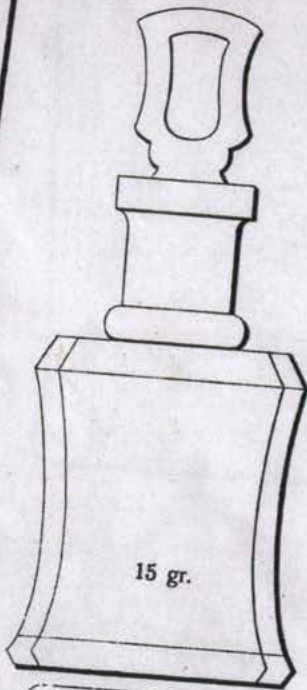

15 gr.

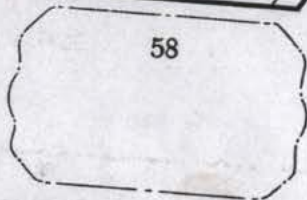

58

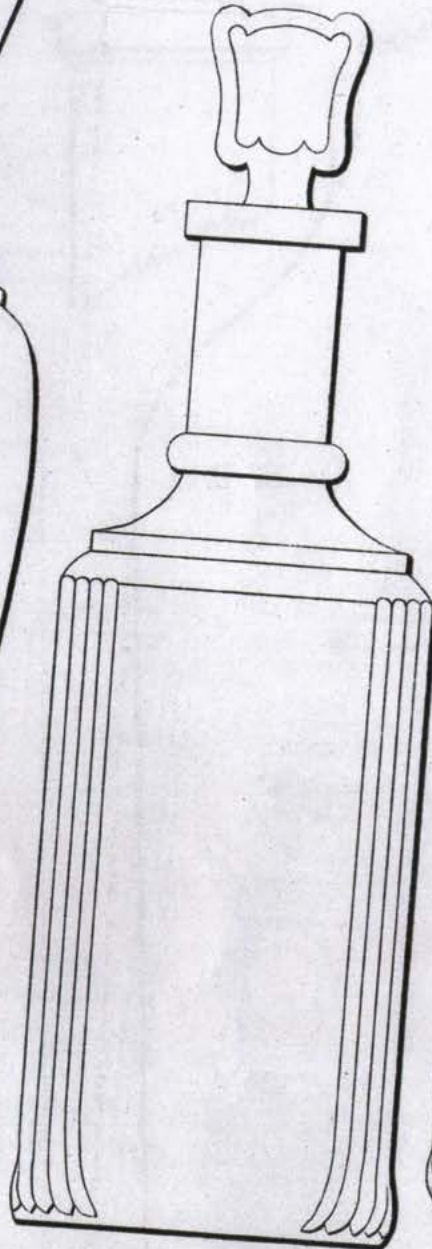

115 gr.

59

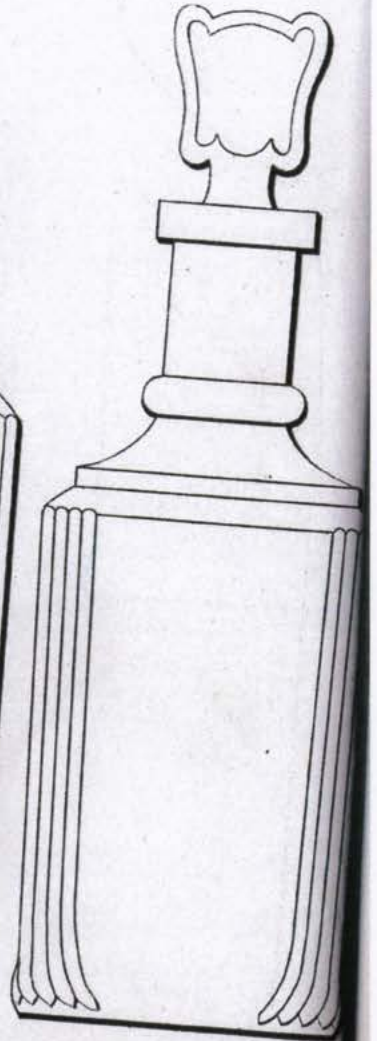

75 gr.

60

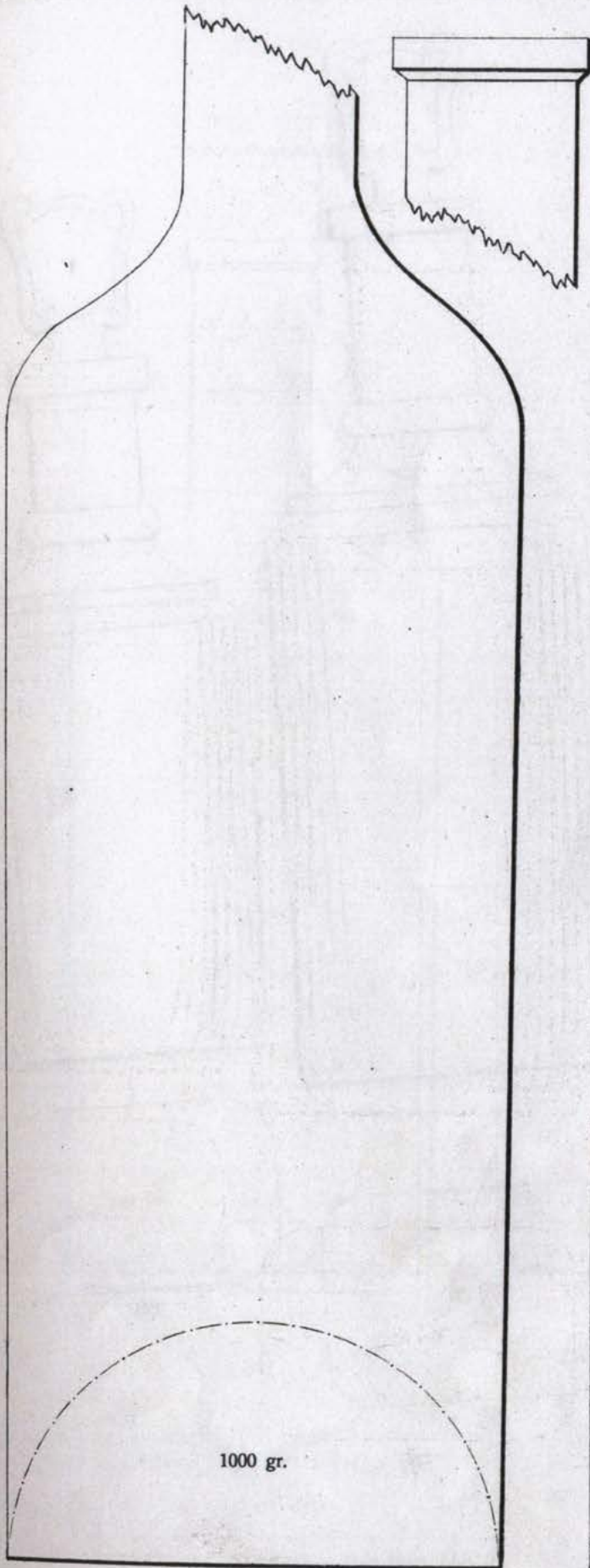

90
Med rundt bröst

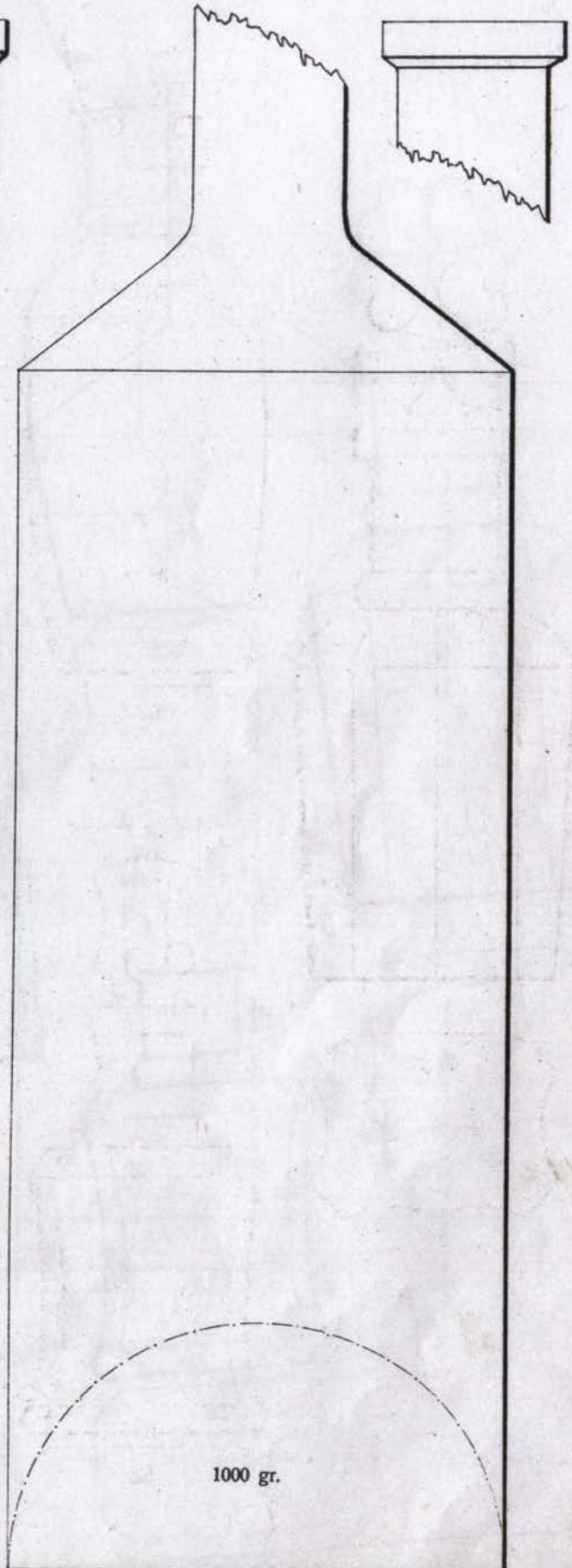

90

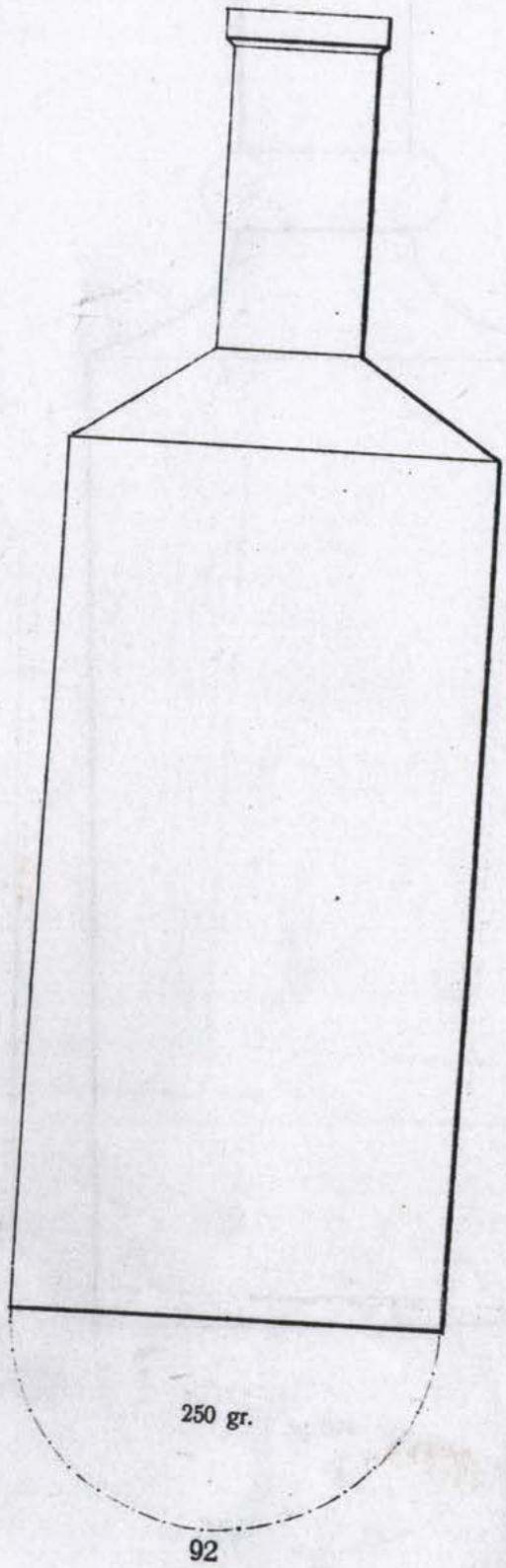
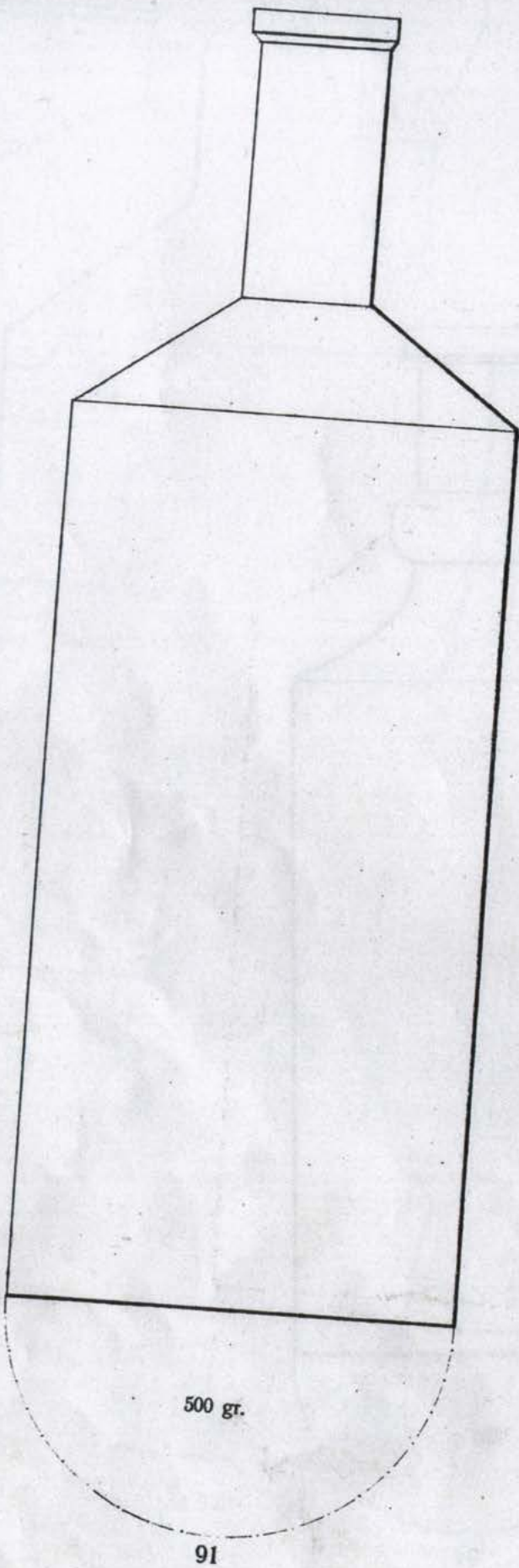

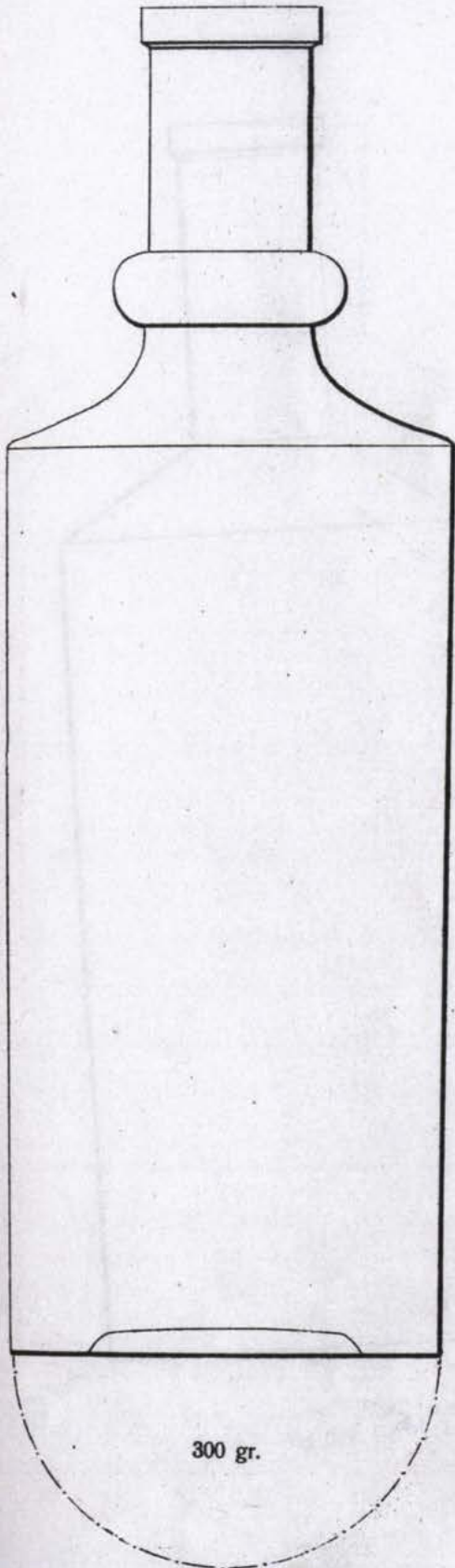

300 gr.

93

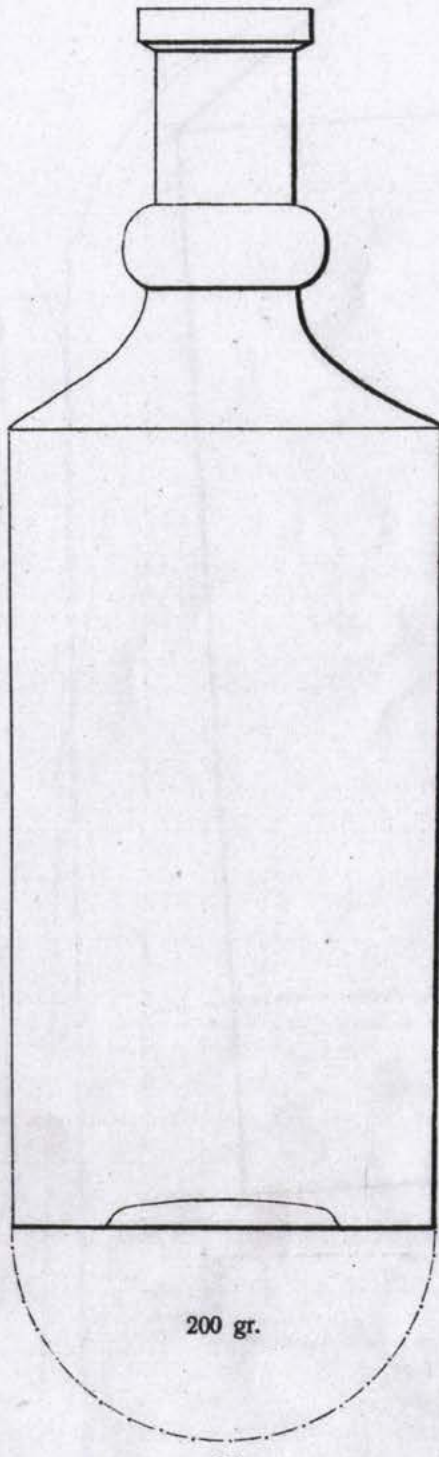

200 gr.

94

dito à 150 gr.

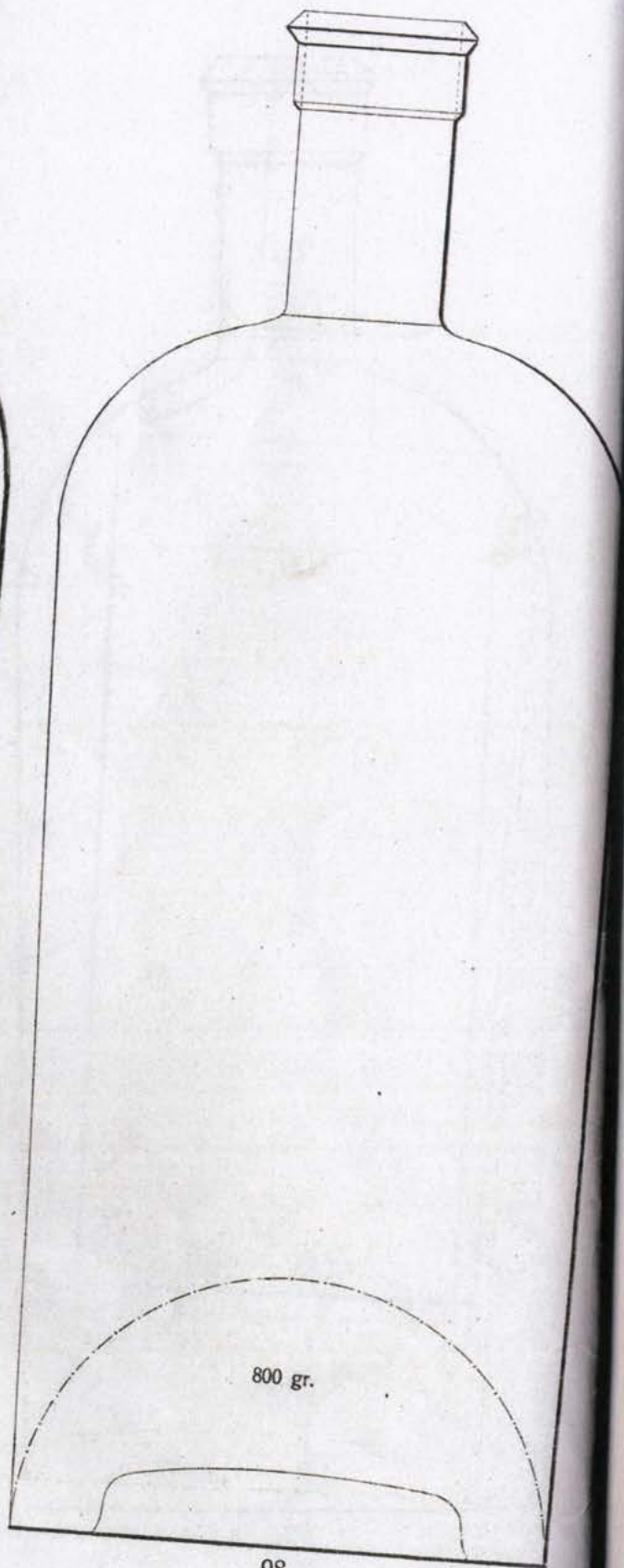
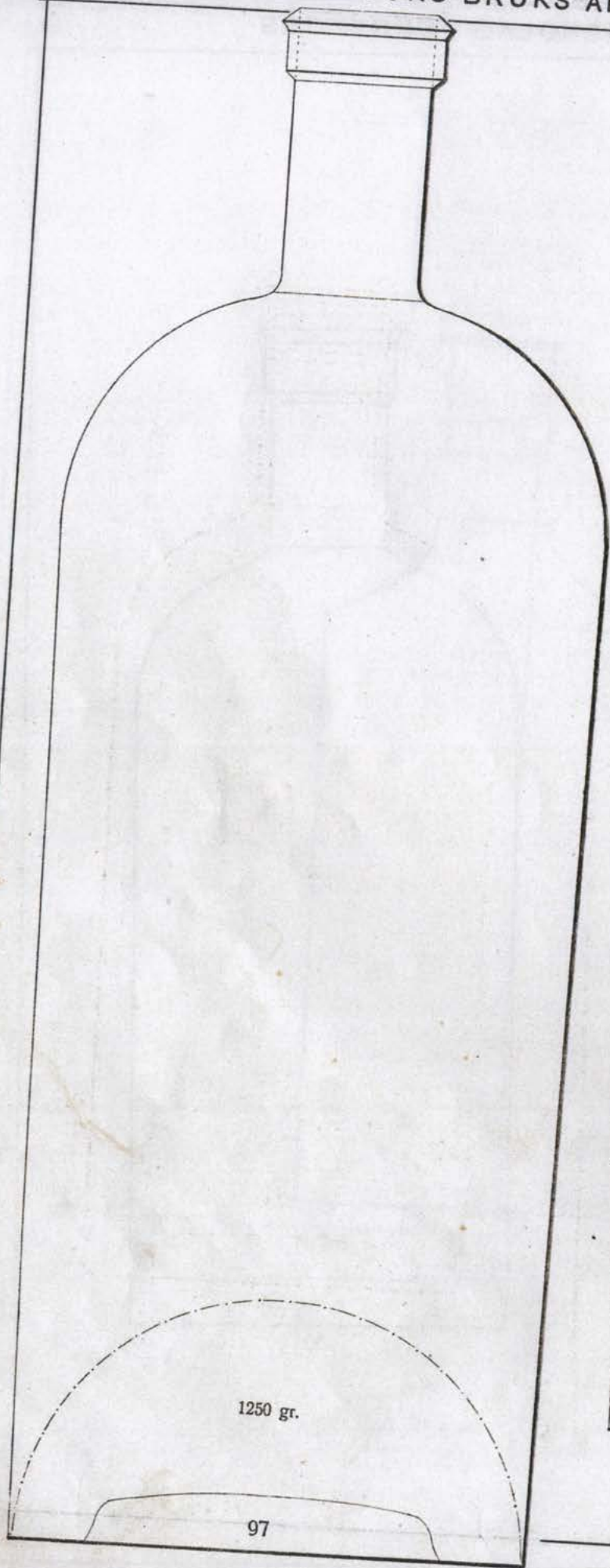

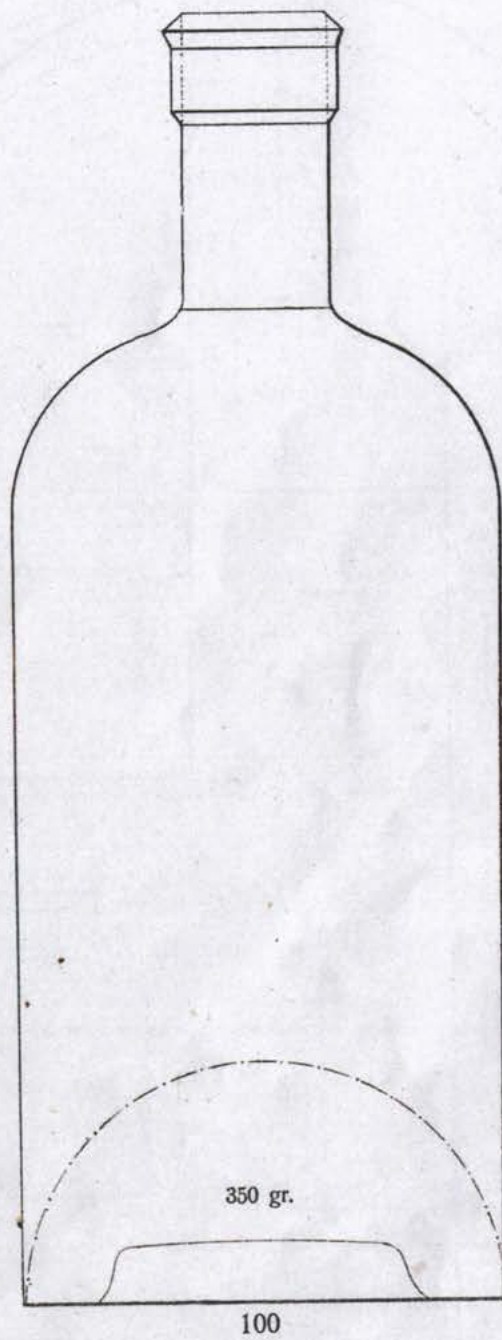
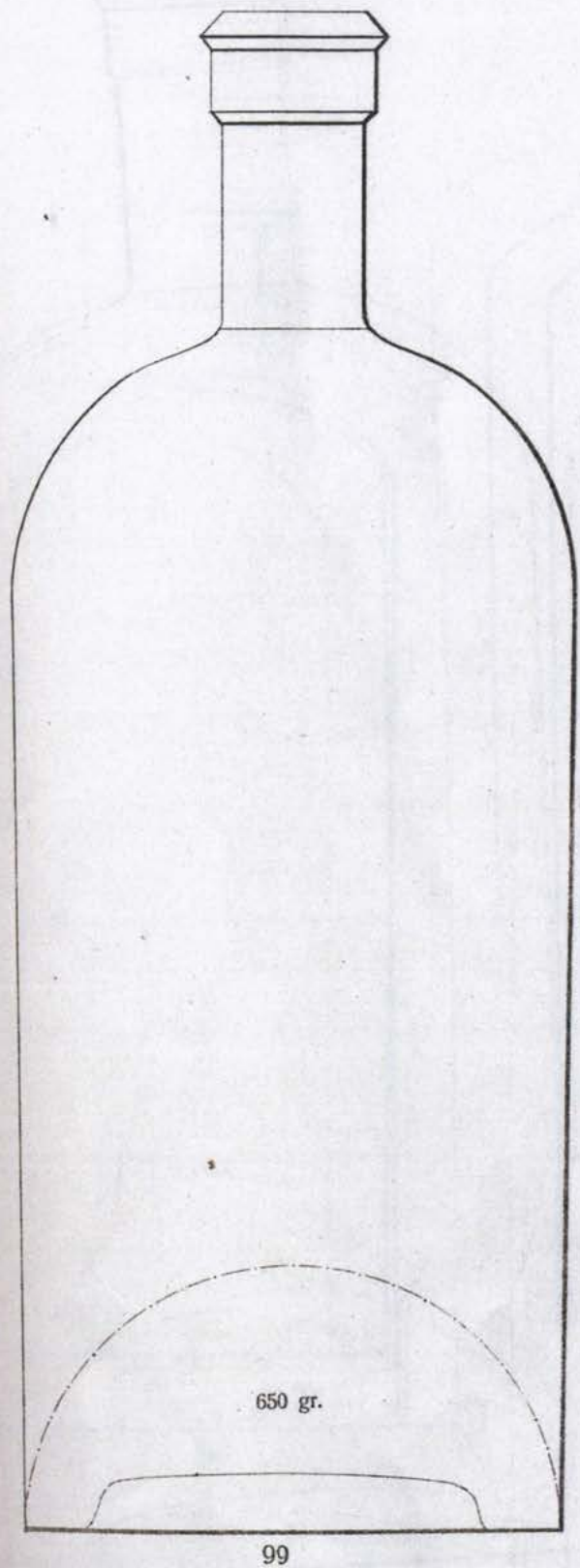

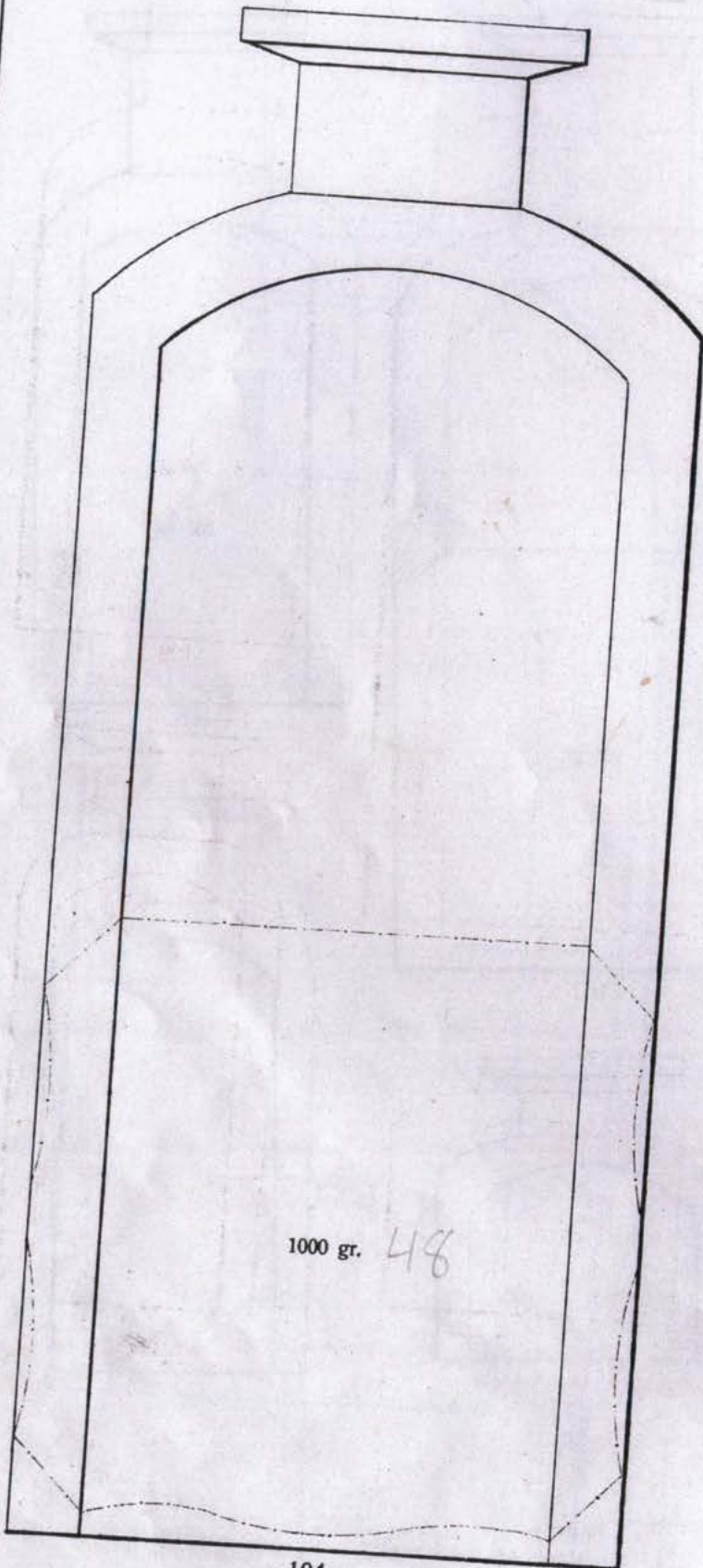

104

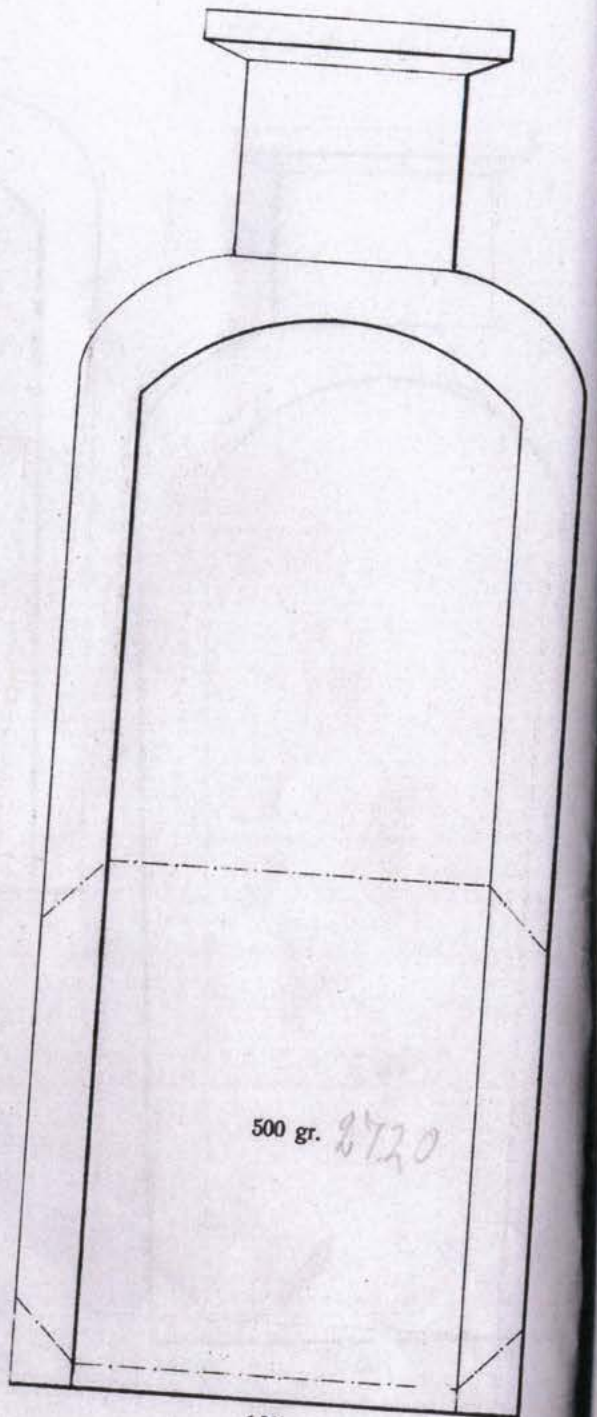

105

✓

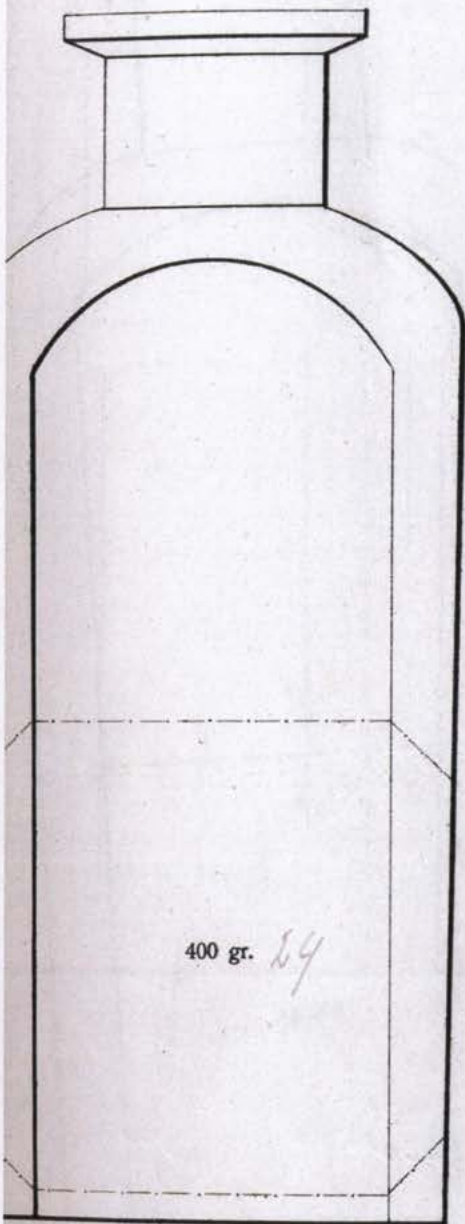

400 gr. 14

106

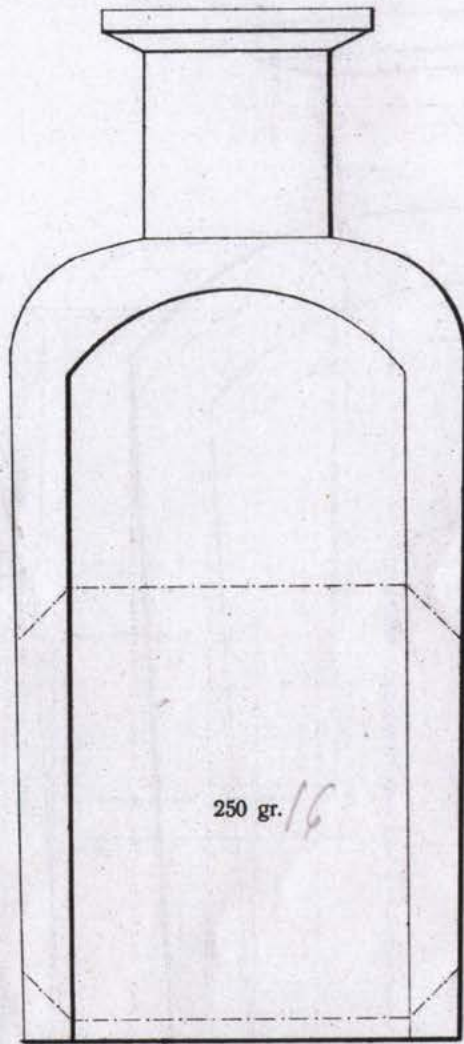

250 gr. 16

107

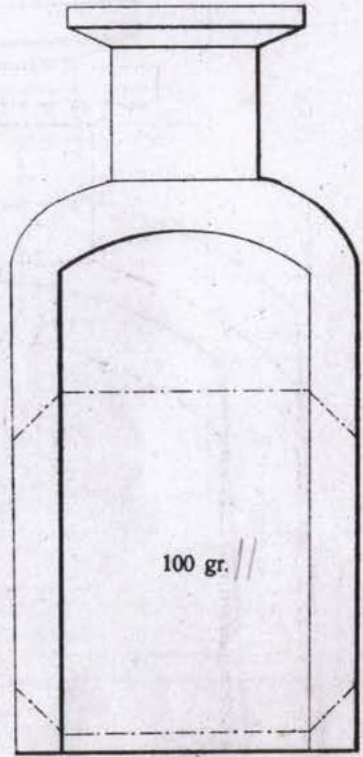

100 gr. 11

108

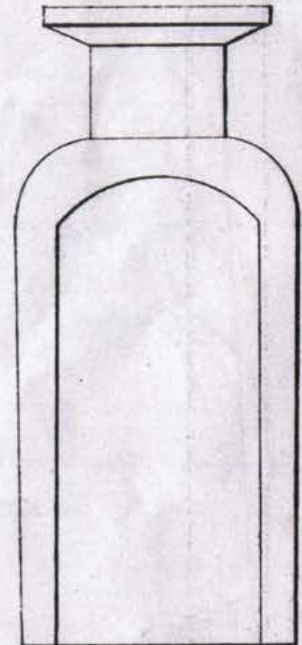

65 gr. 850

109

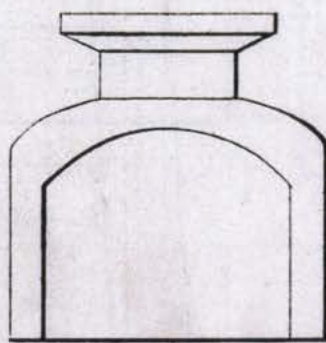

25 gr. 8
500/50

400

110



111

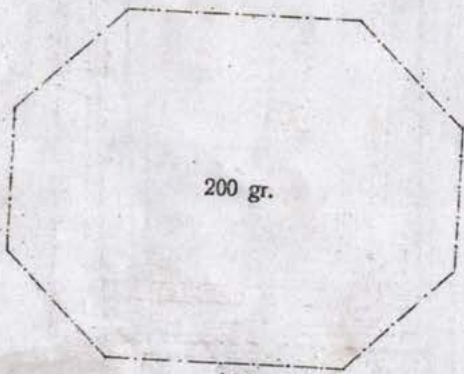
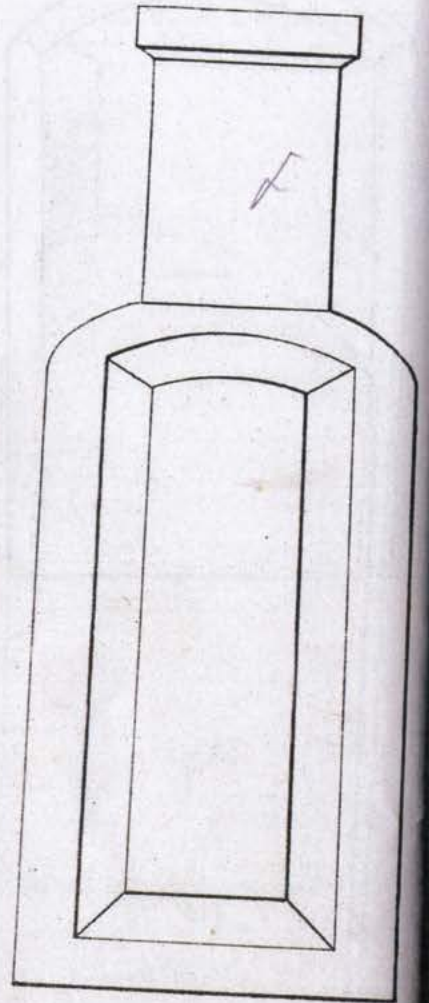
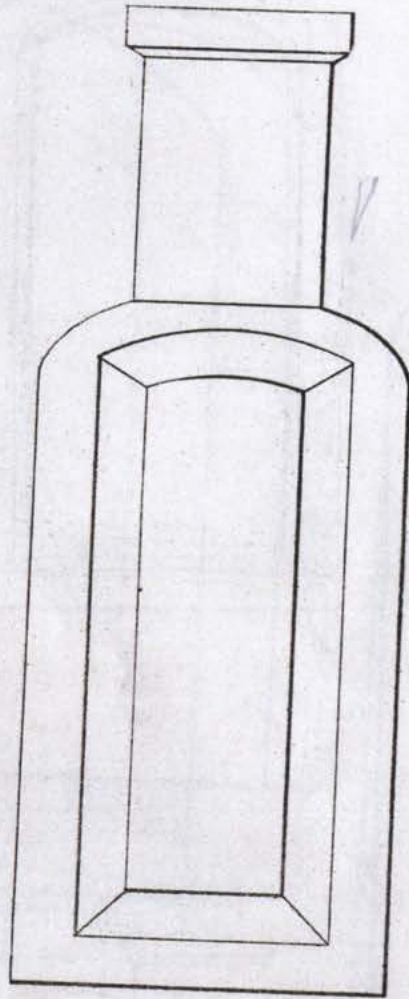
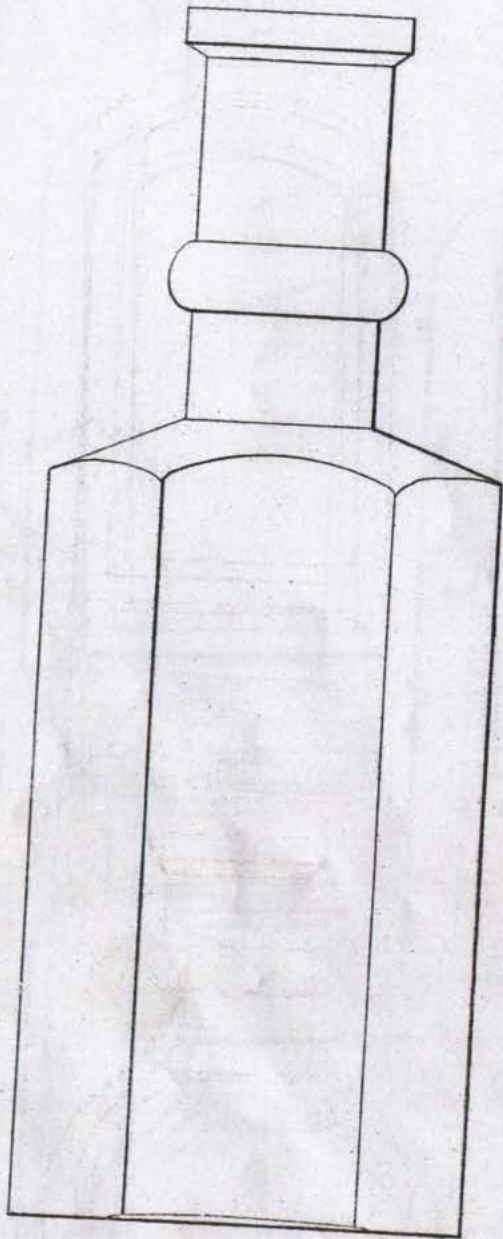

200 gr.

111

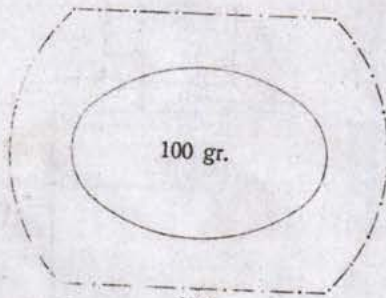

100 gr.

112

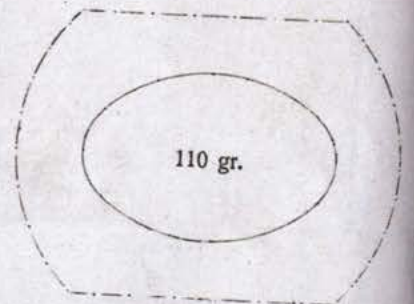

110 gr.

113

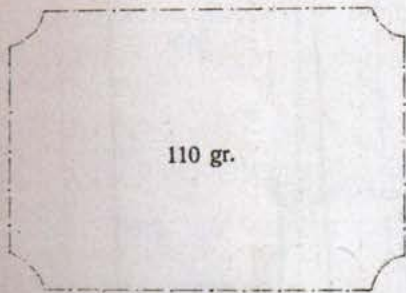
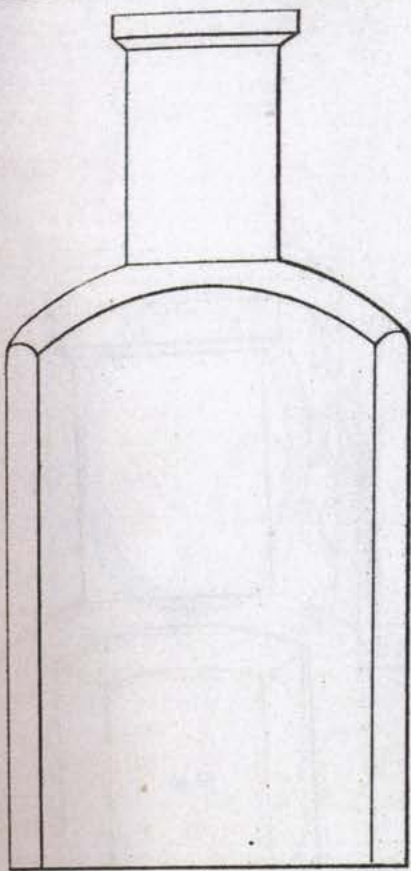

110 gr.

114

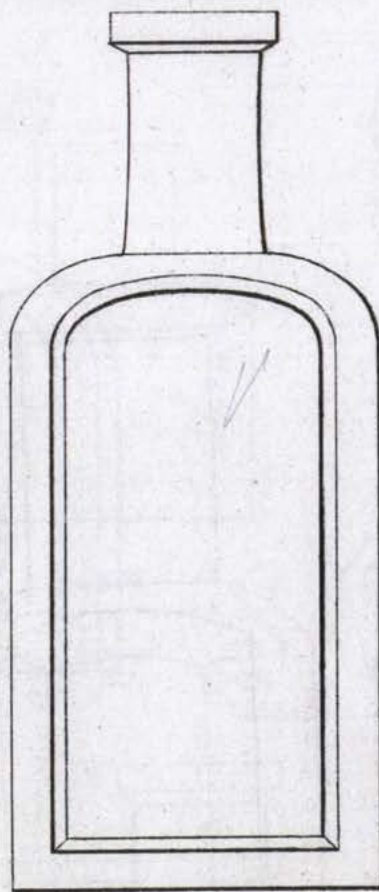

50 gr.

115

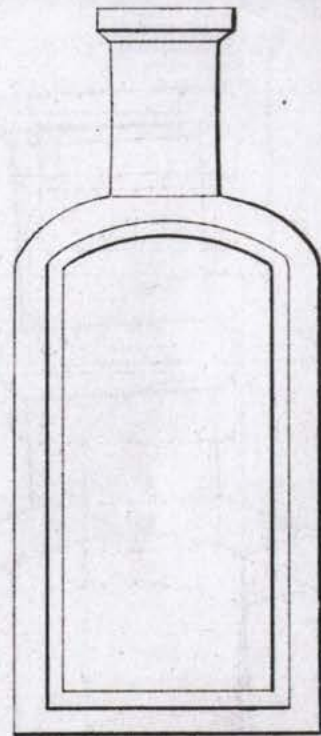

35 gr.

116

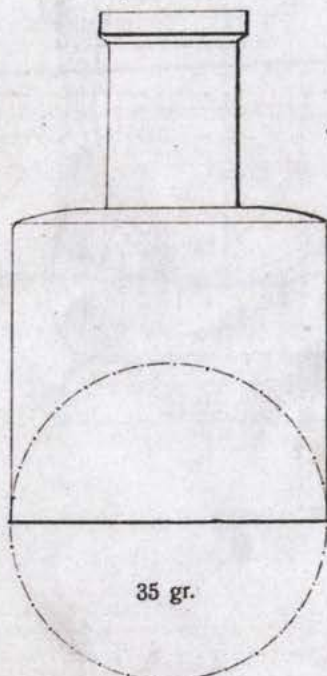

35 gr.

118

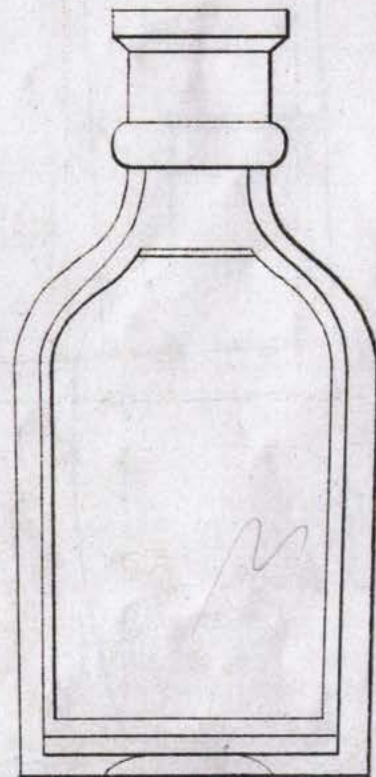

40 gr.

117

119

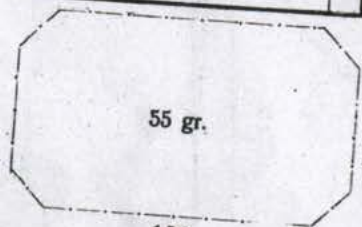
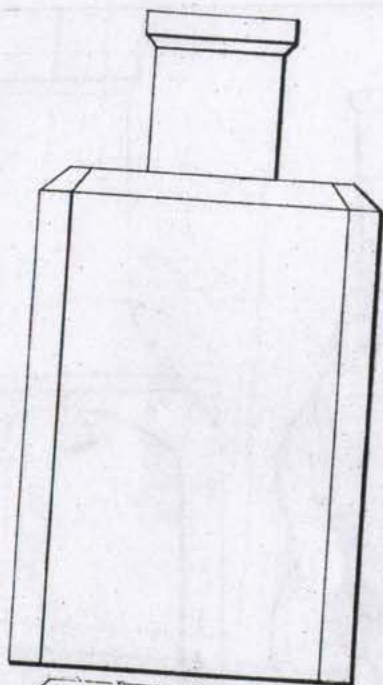

55 gr.

120

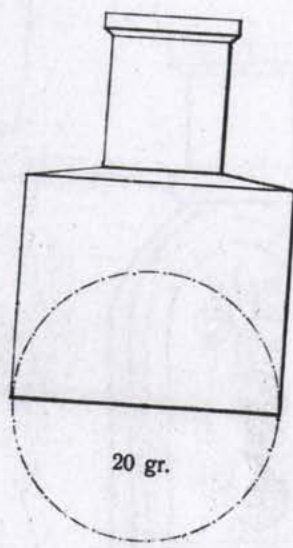

20 gr.

121

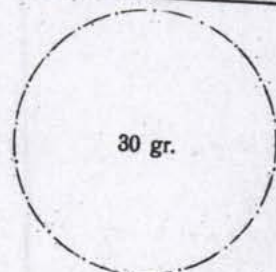
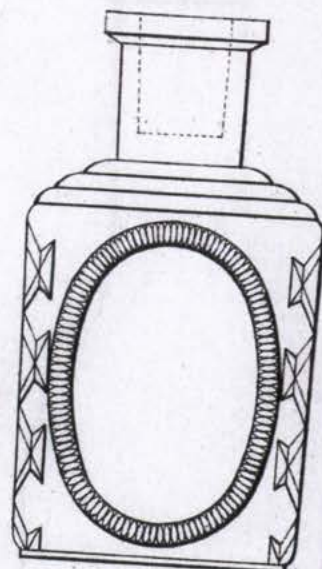

30 gr.

122

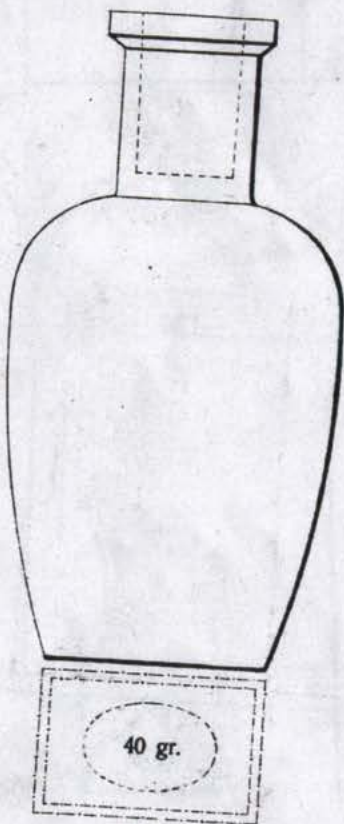

40 gr.

123

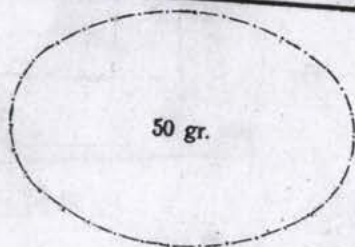
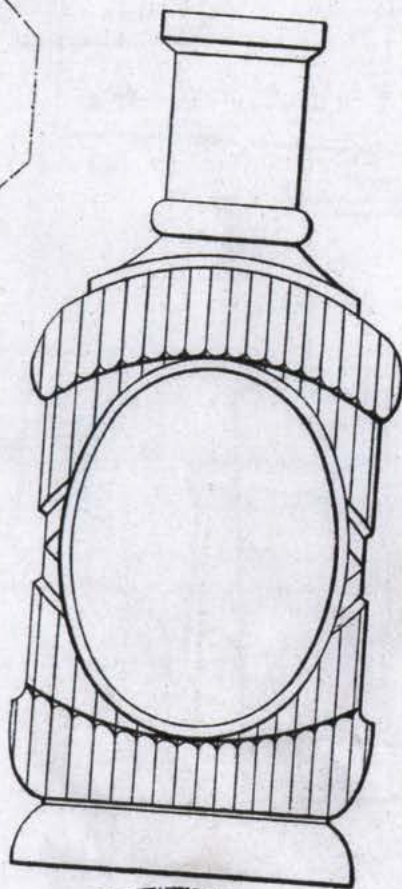

50 gr.

124



25 gr.

125

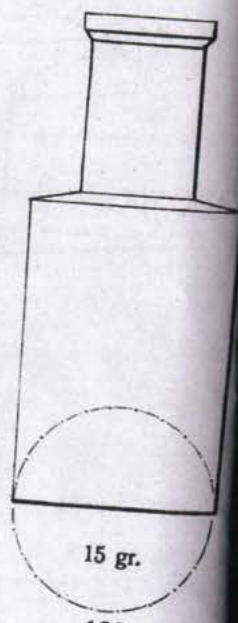

15 gr.

126

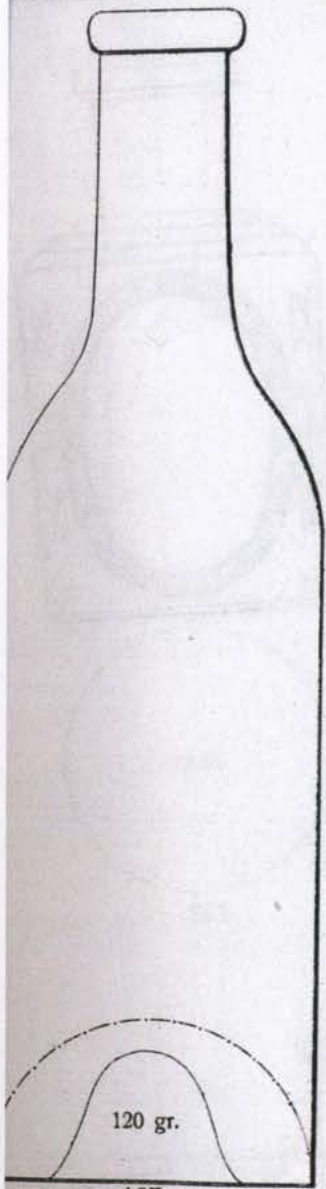

10 gr.

128

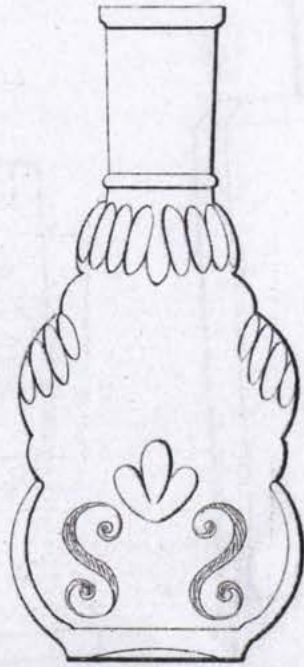

10 gr.

129

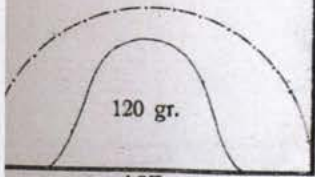
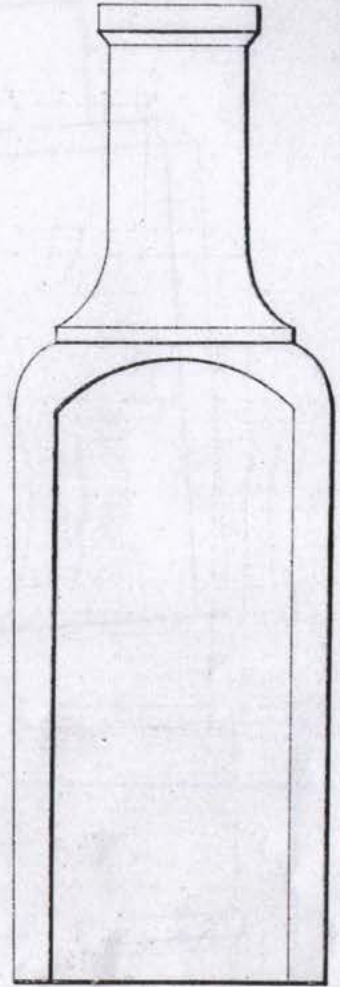

120 gr.

127

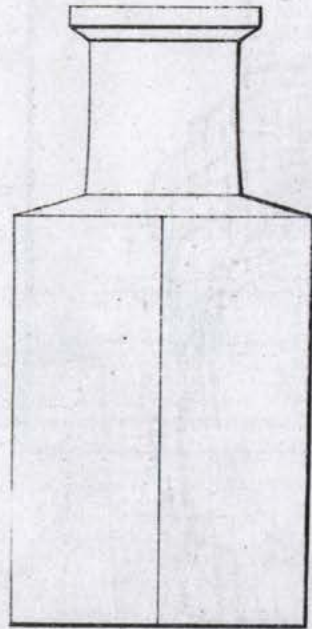

60 gr.

131



40 gr.

133

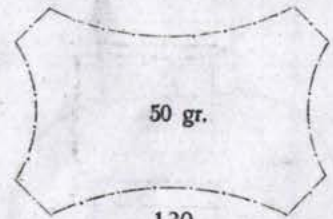

50 gr.

130

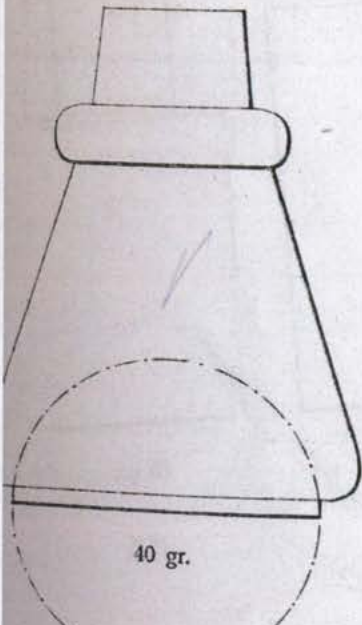

40 gr.

132

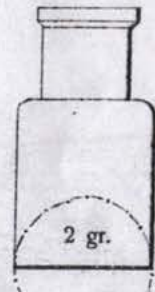

2 gr.

134



45 gr.

135

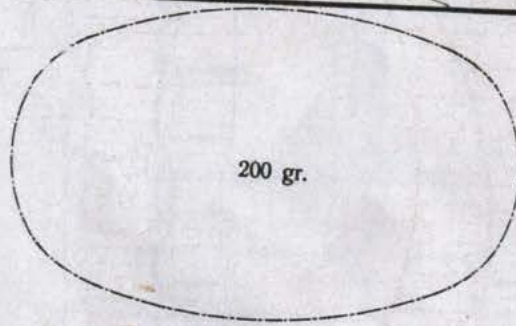
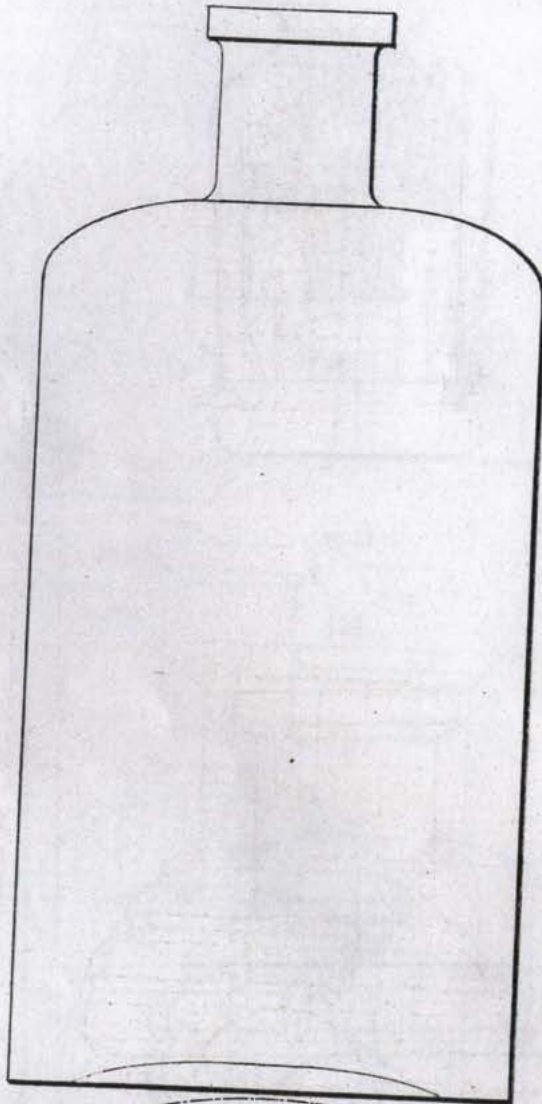

200 gr.

137

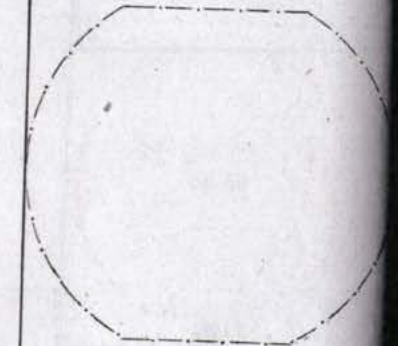
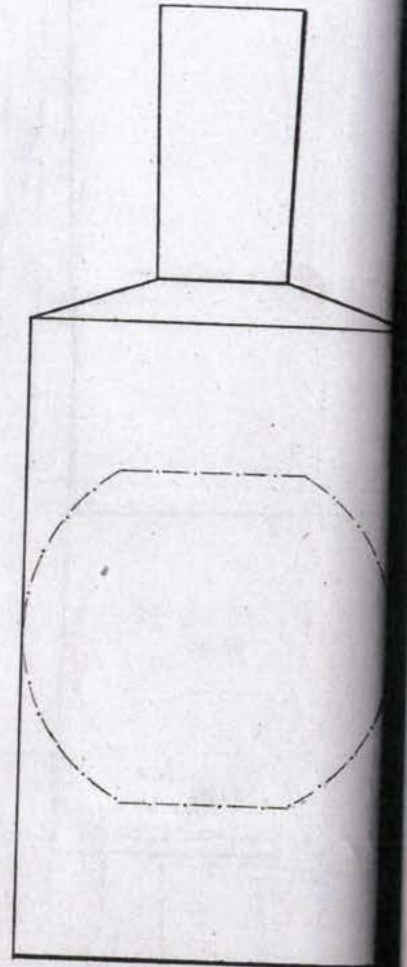

125 gr.

138

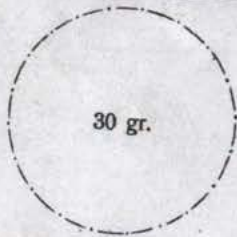
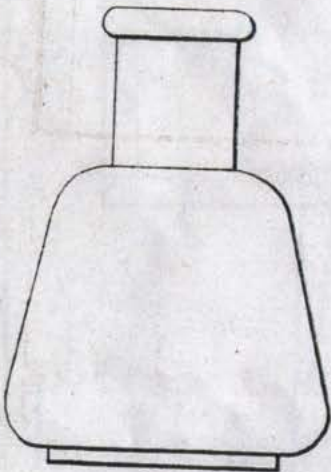

30 gr.

136

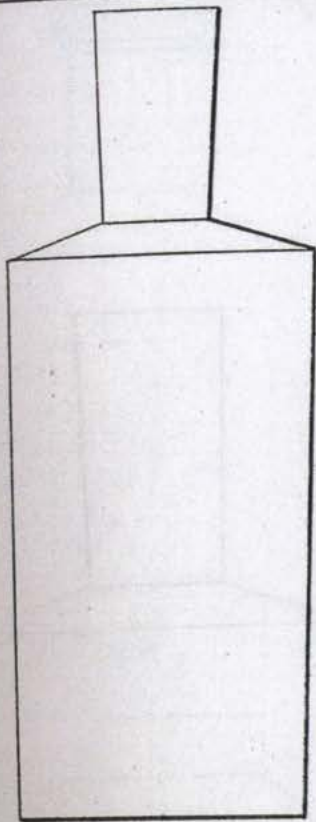

139

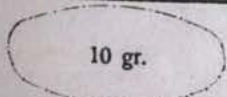

140

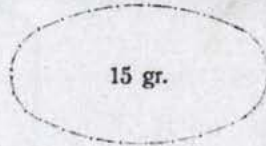
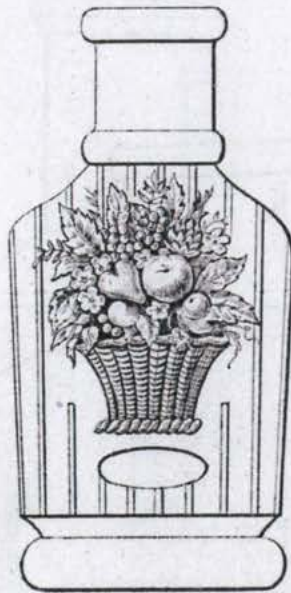

141

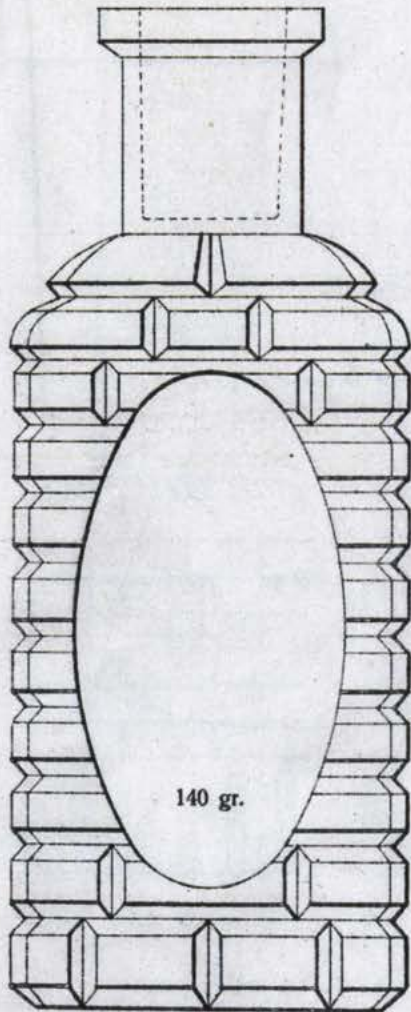

140 gr.

142

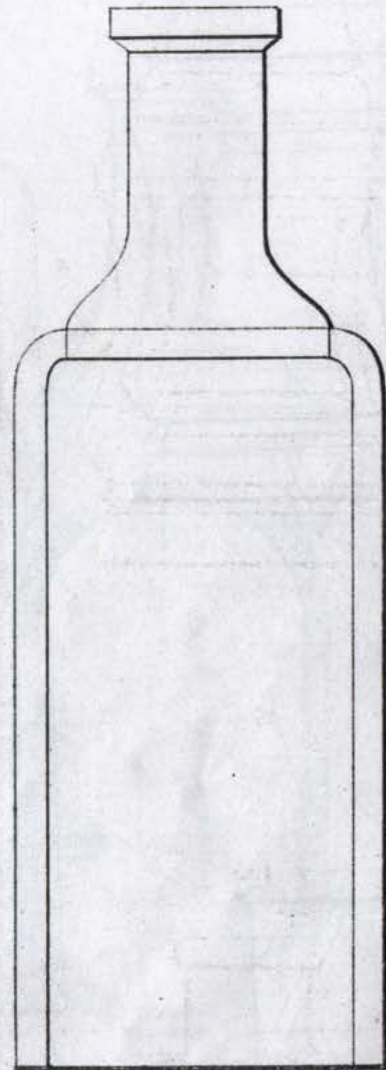

120 gr.

143

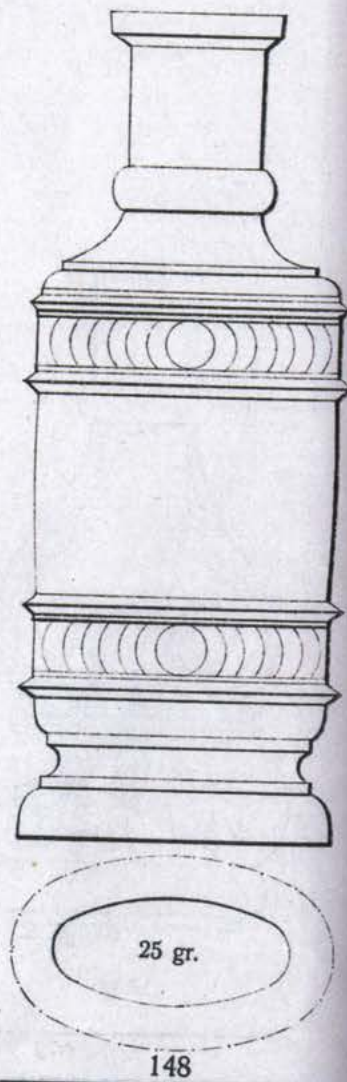
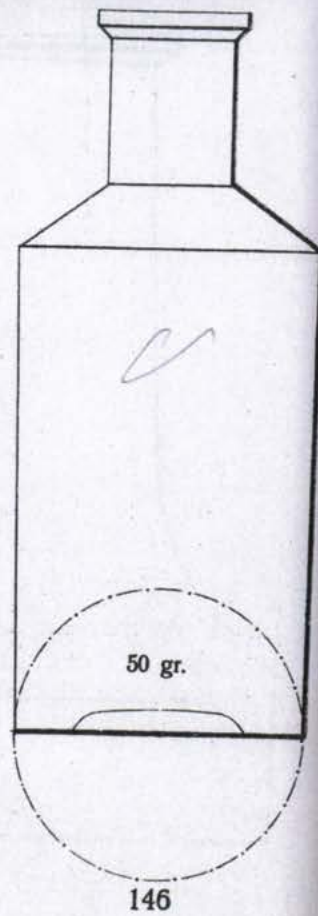
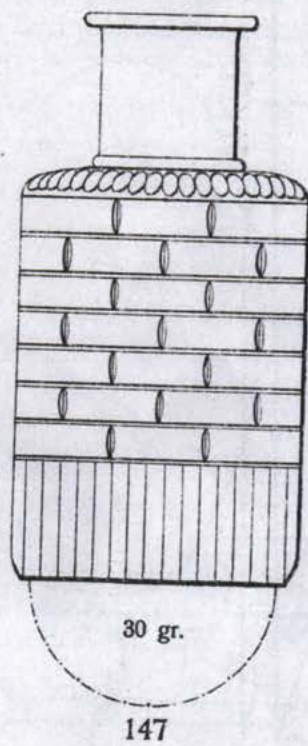
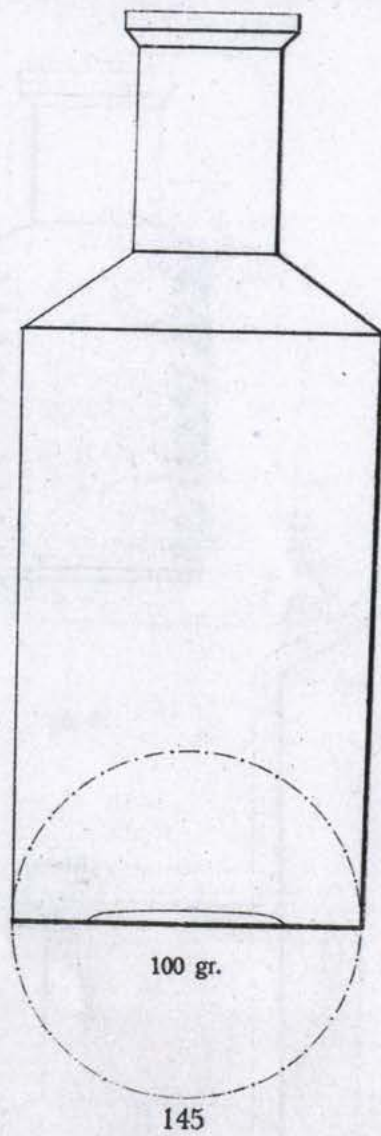
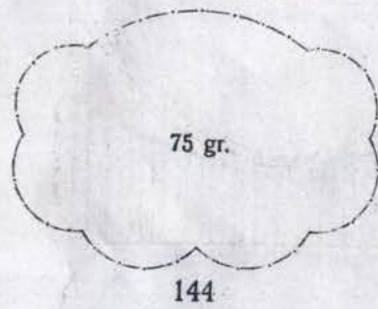
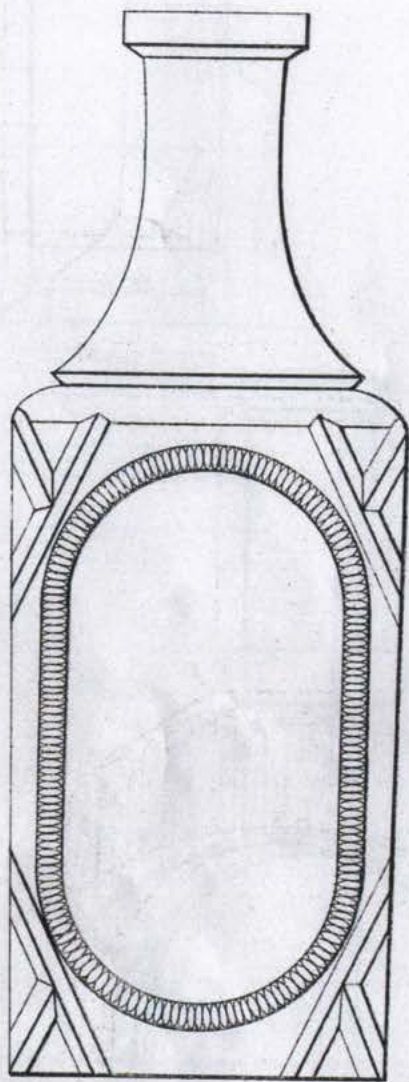

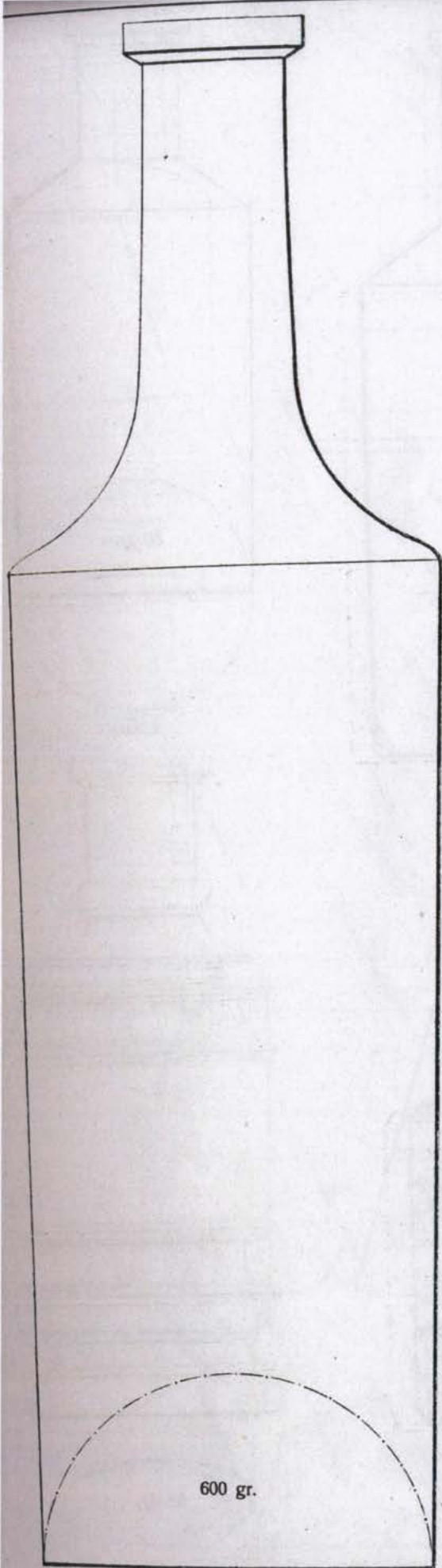

600 gr.

149

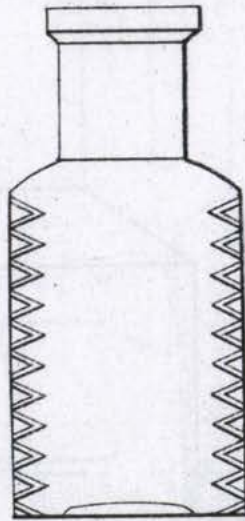

15 gr.

150

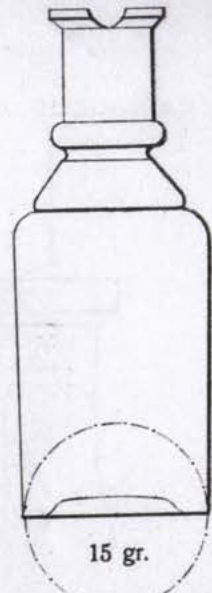

15 gr.

151

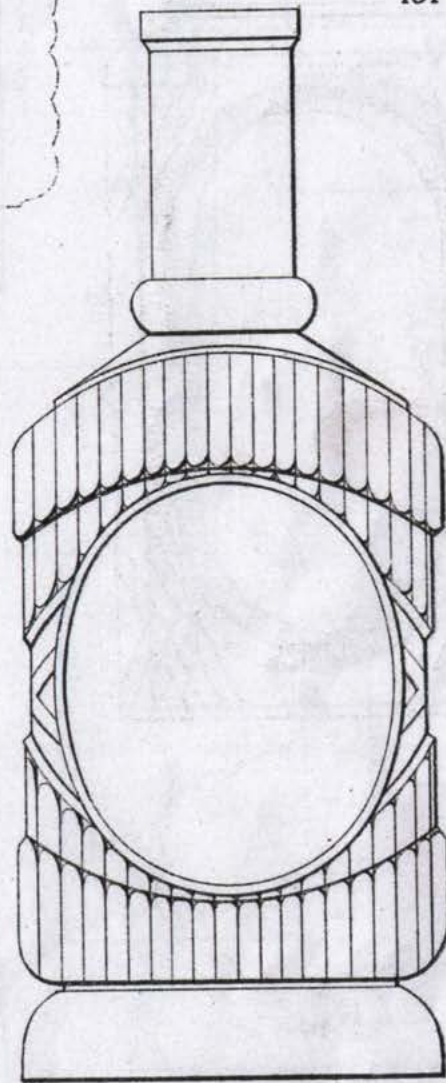

60 gr.

152

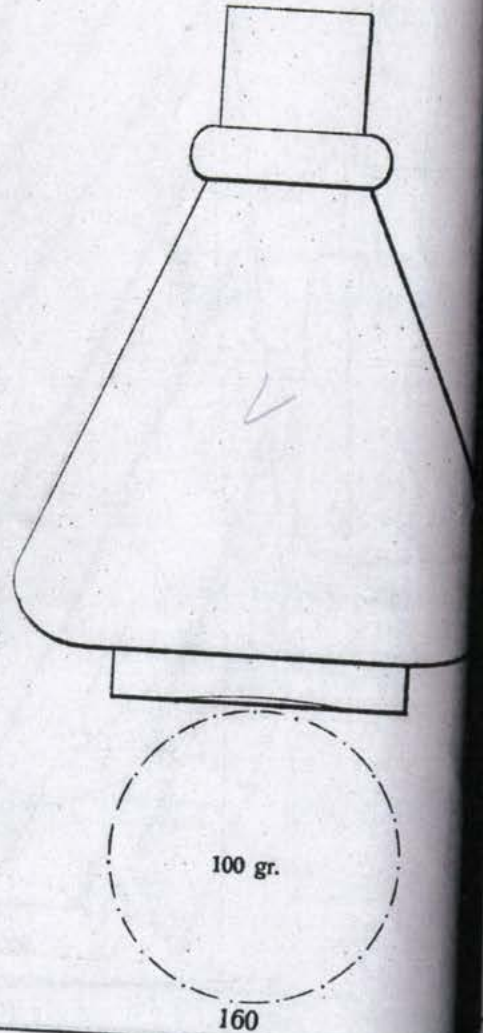
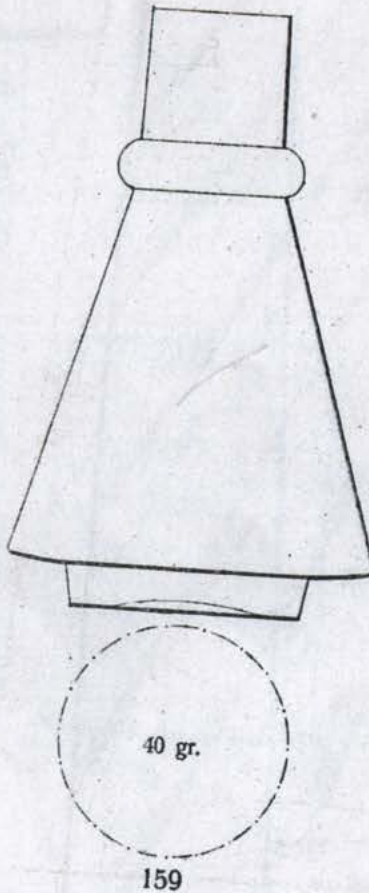
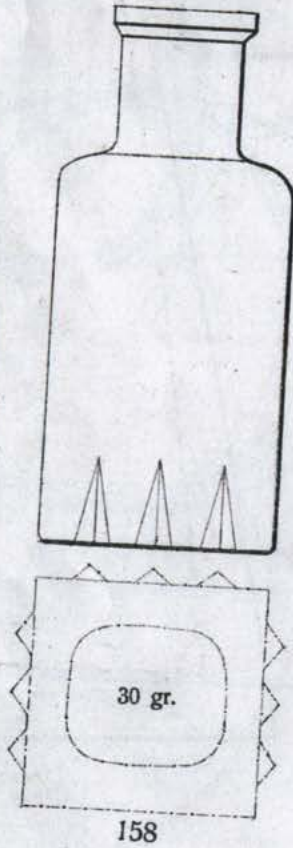
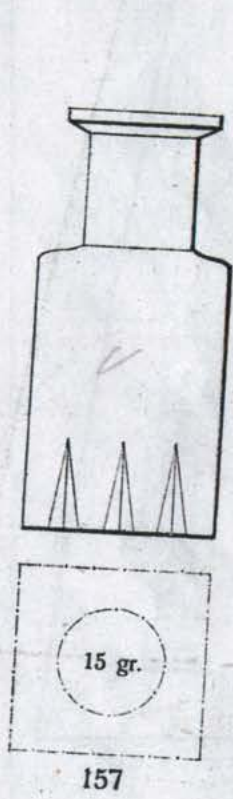
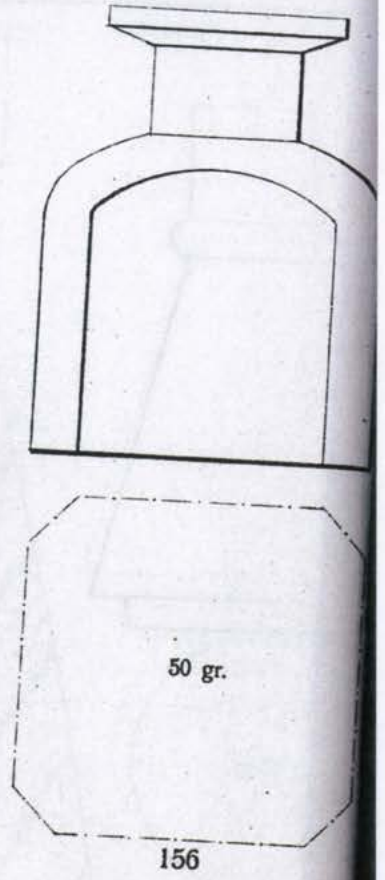
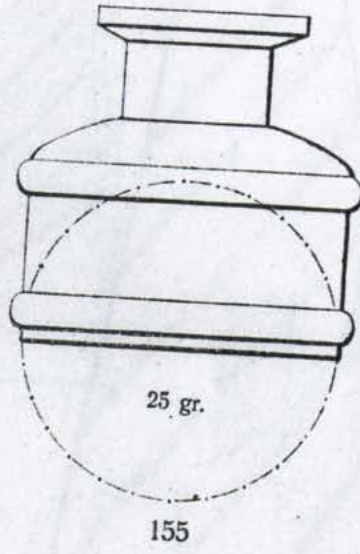
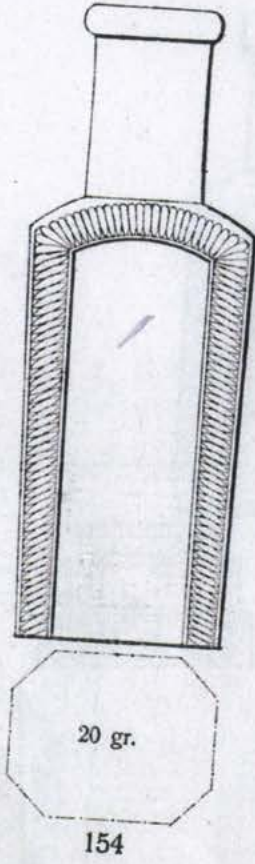
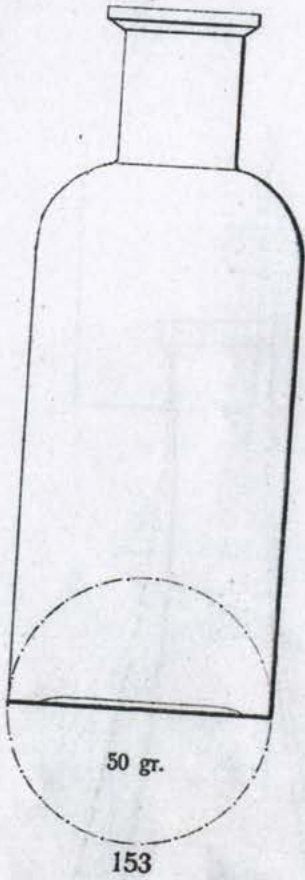

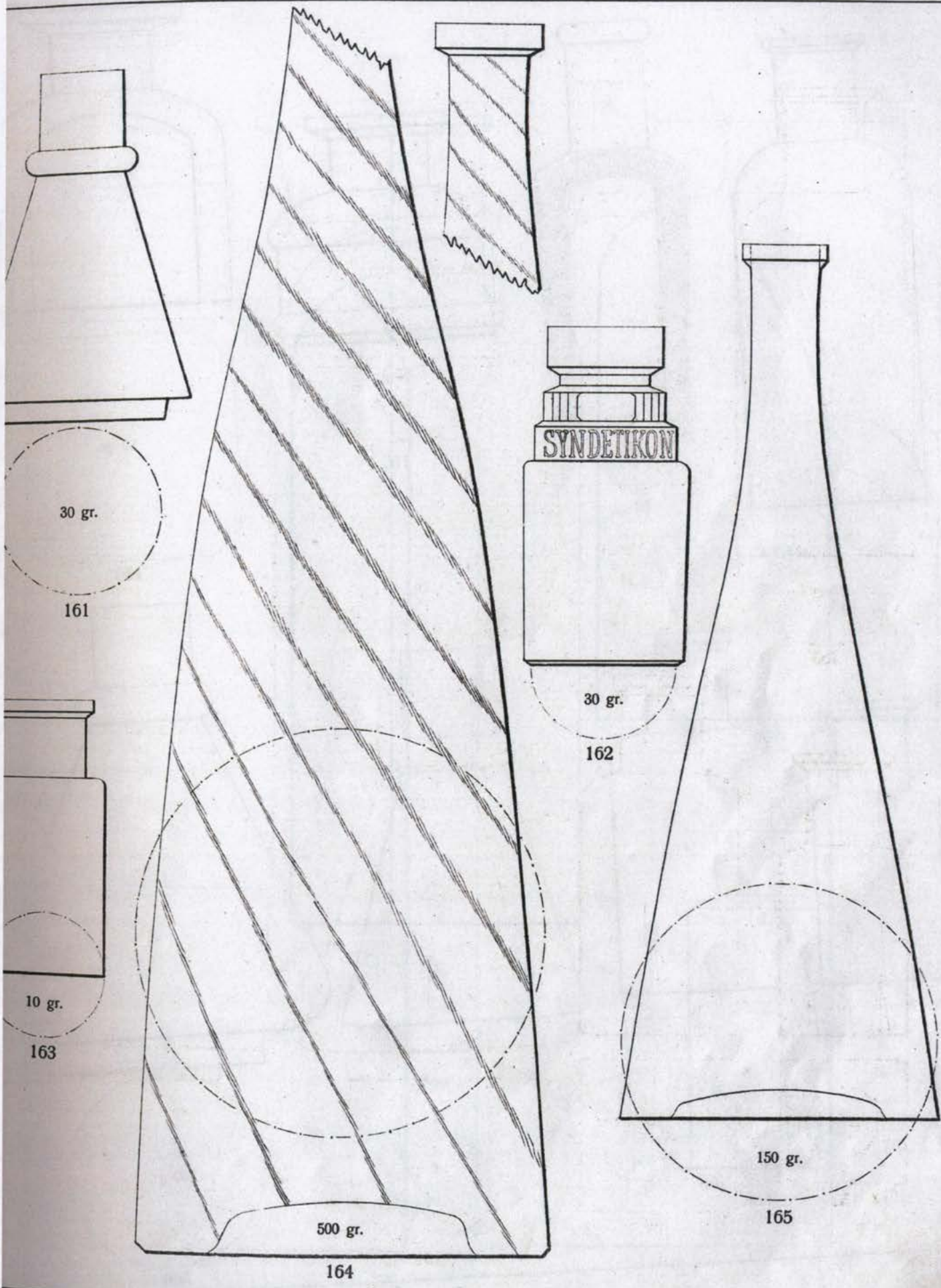

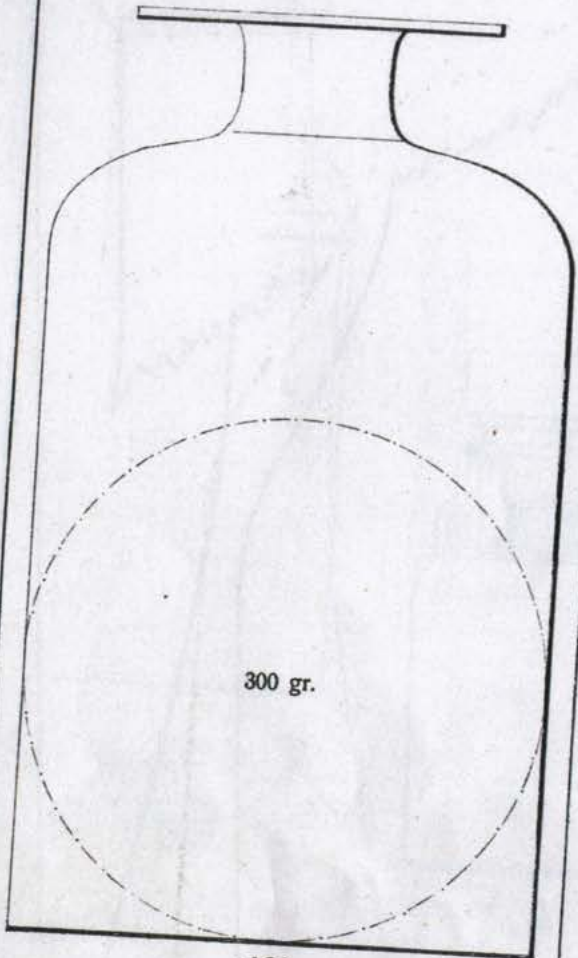

300 gr.

166

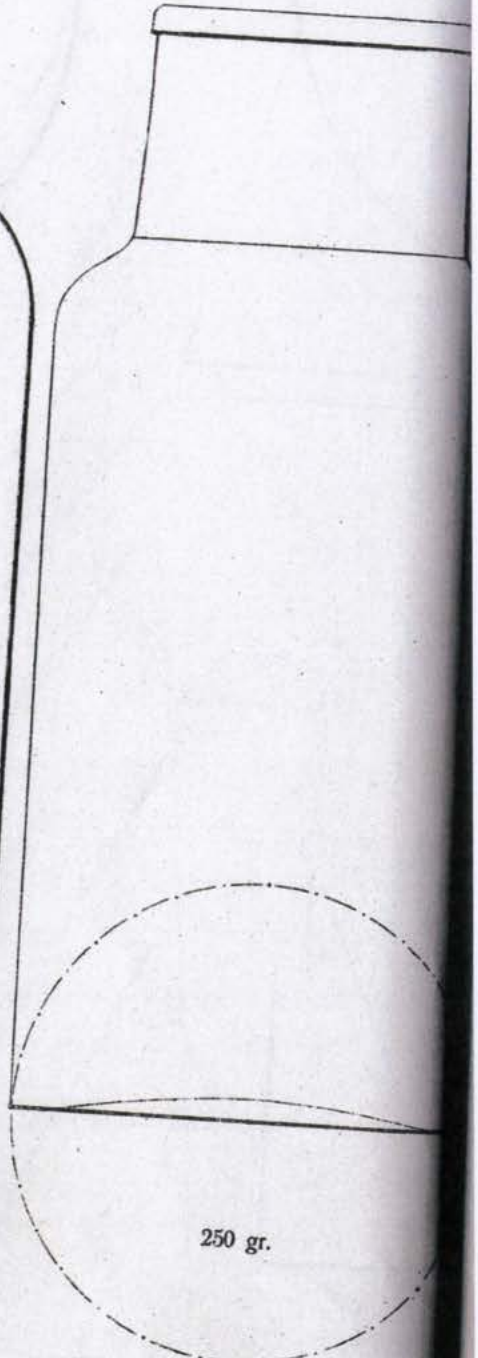
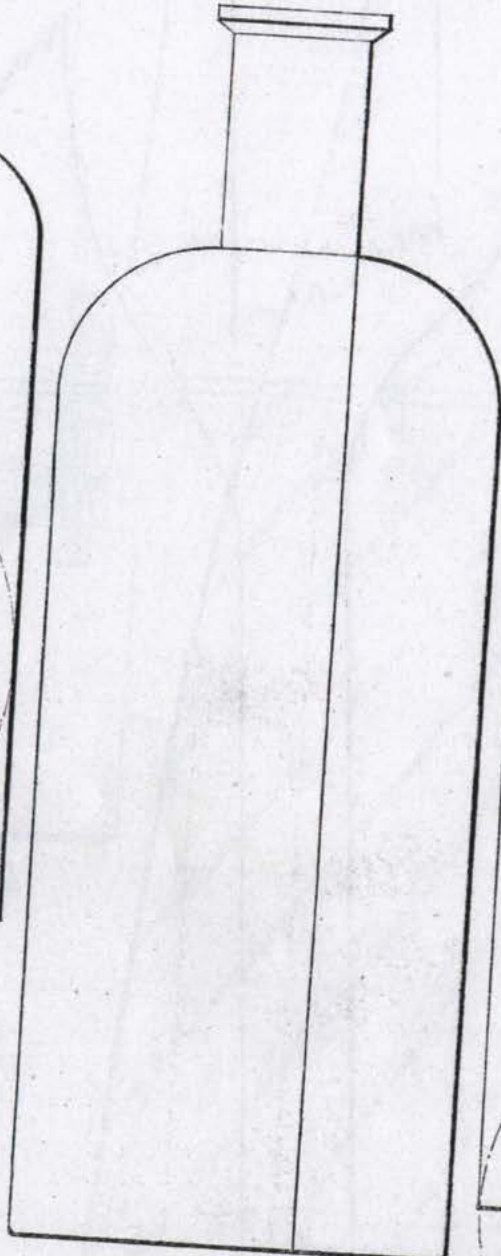

250 gr.

168



25 gr.

169

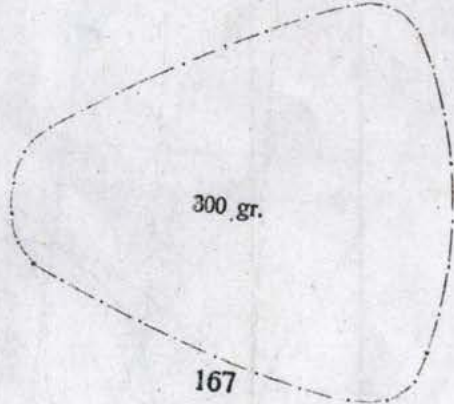

300 gr.

167

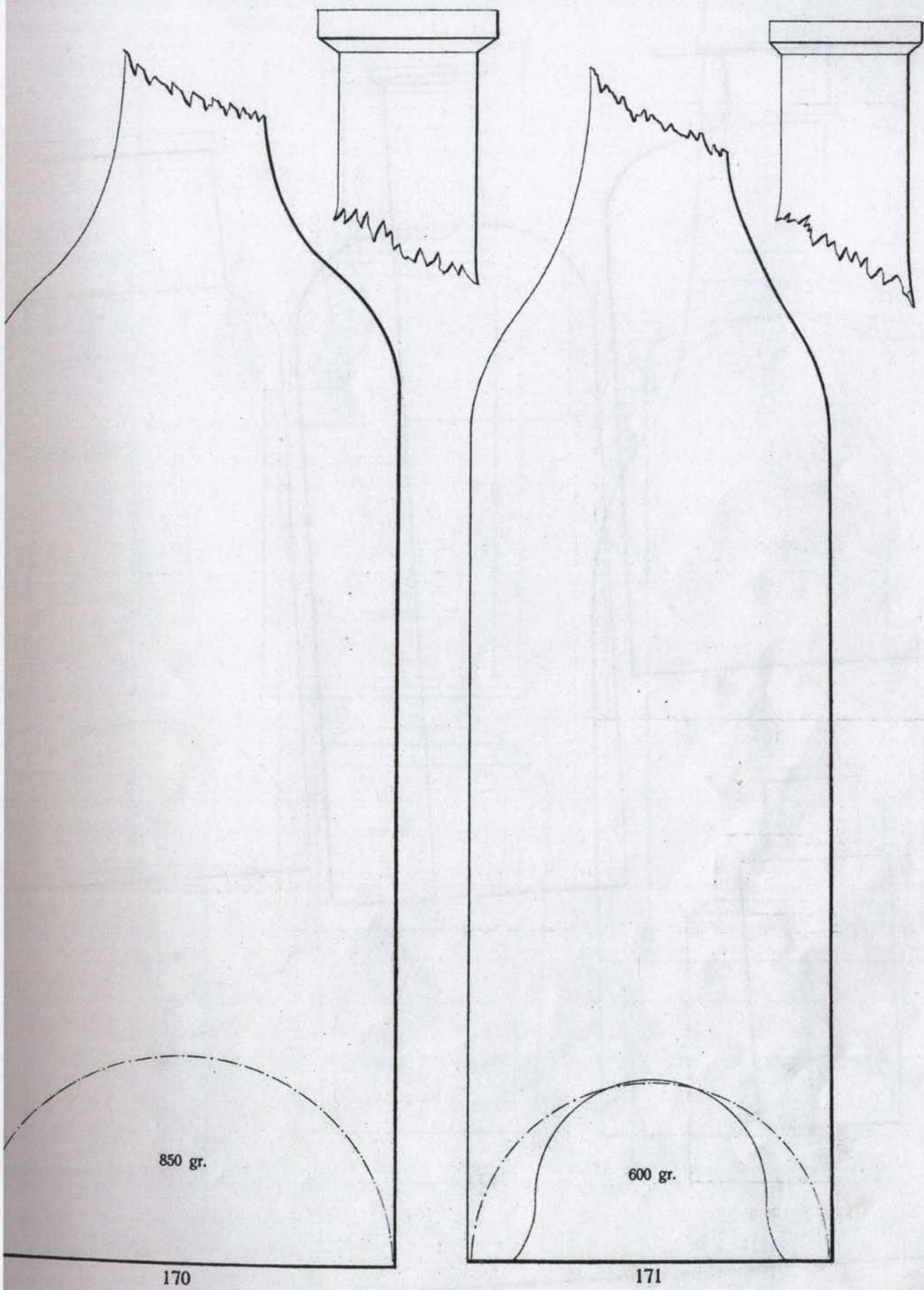

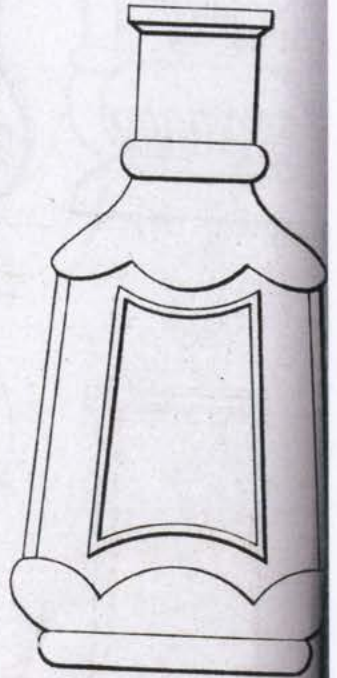
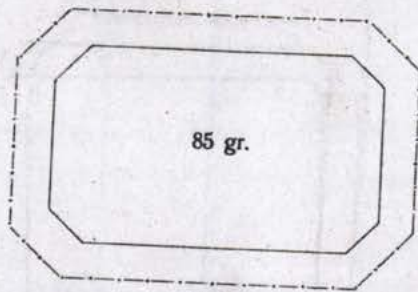
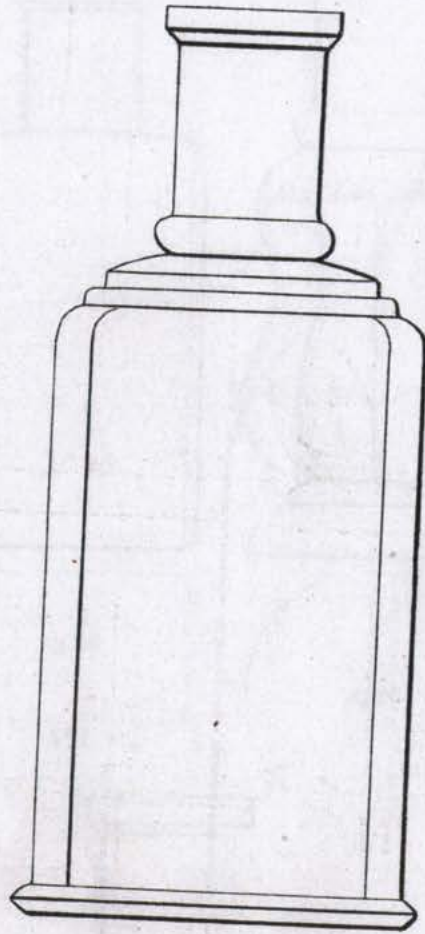
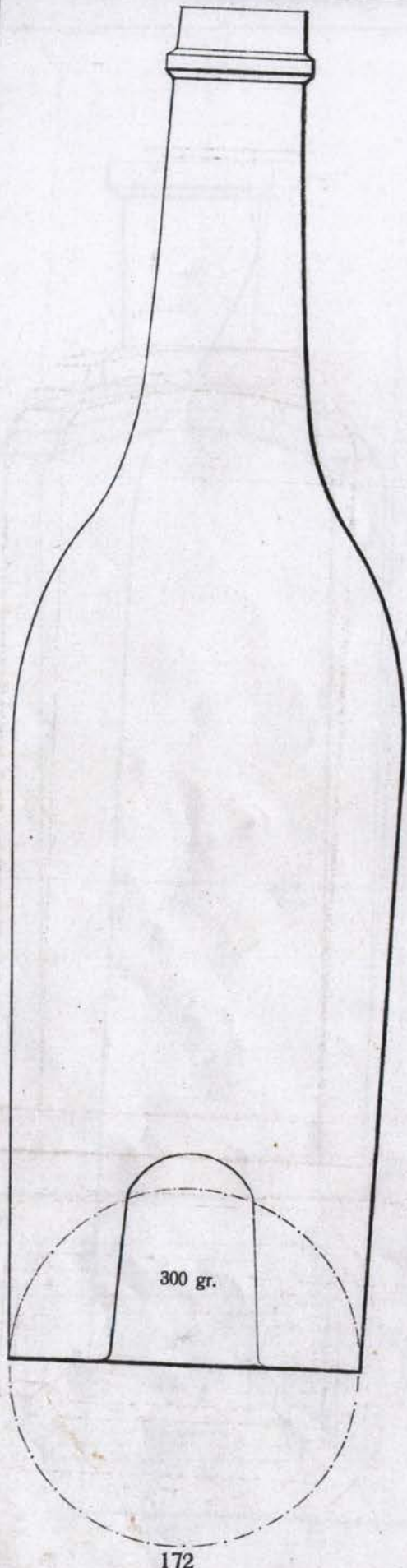

172

173

174

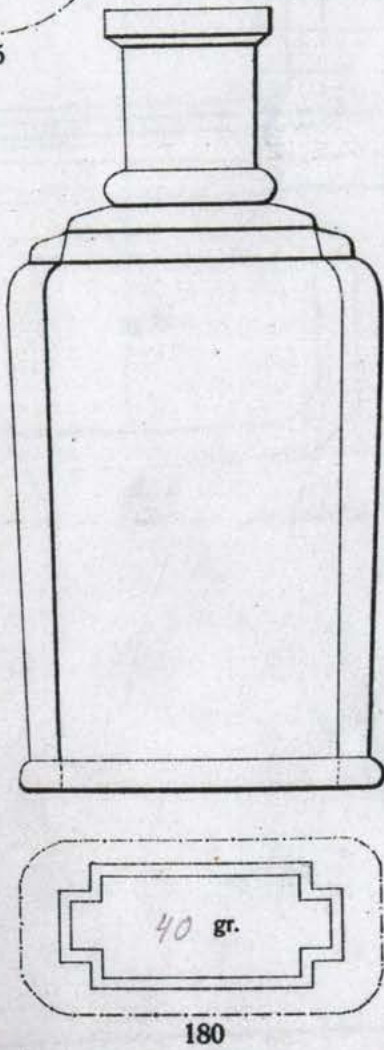
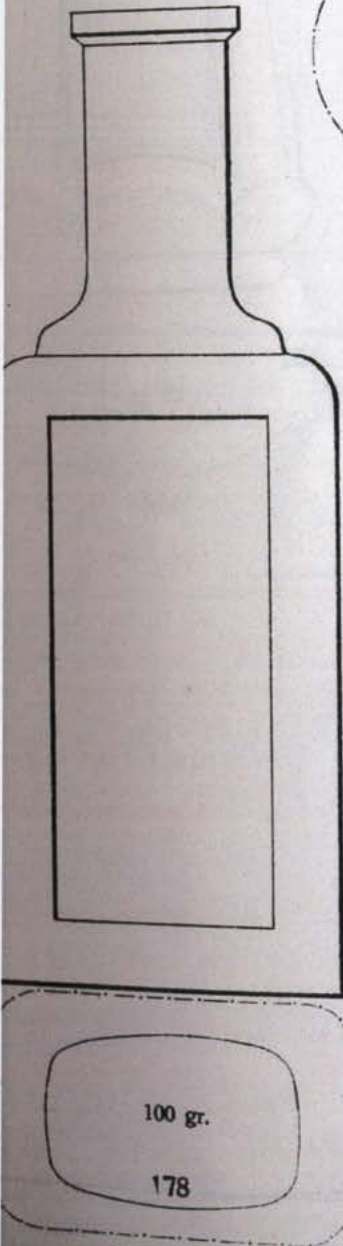
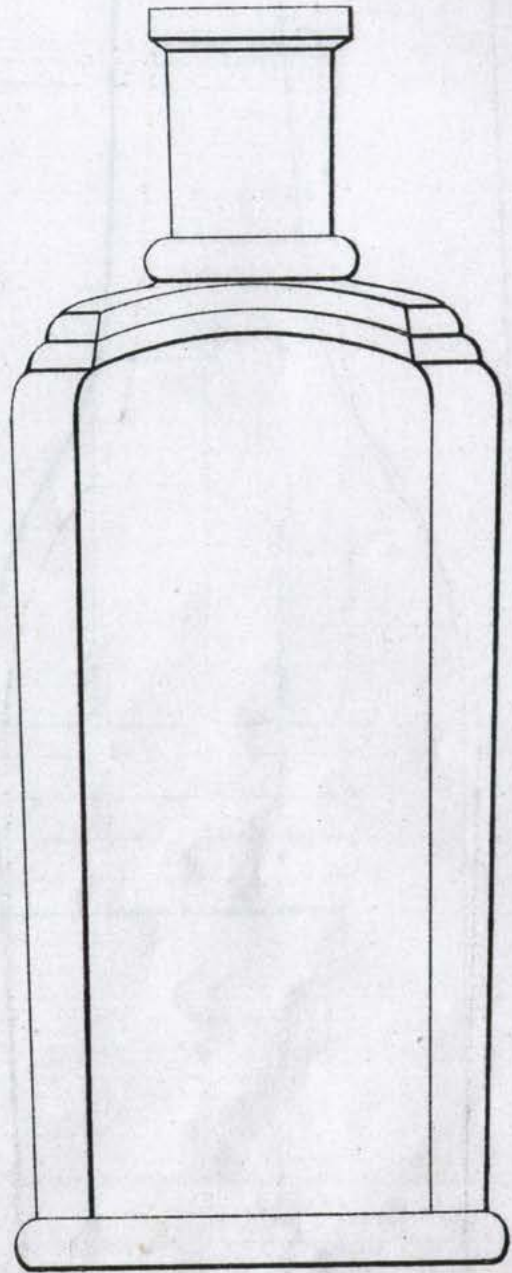
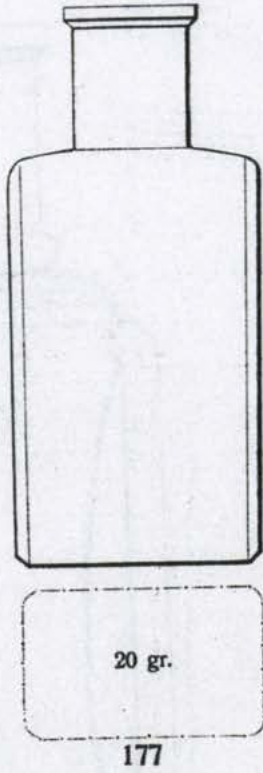
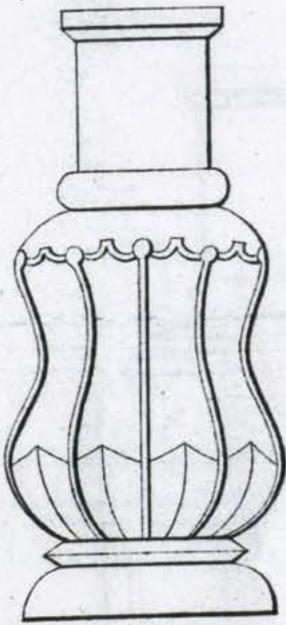
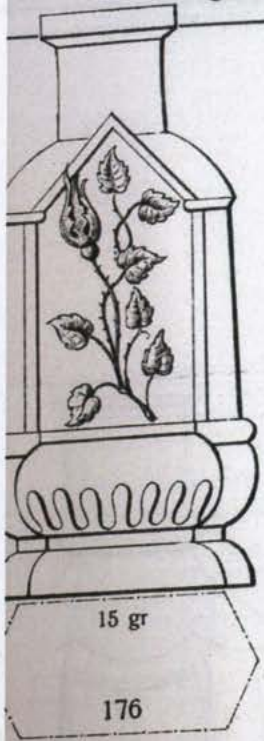

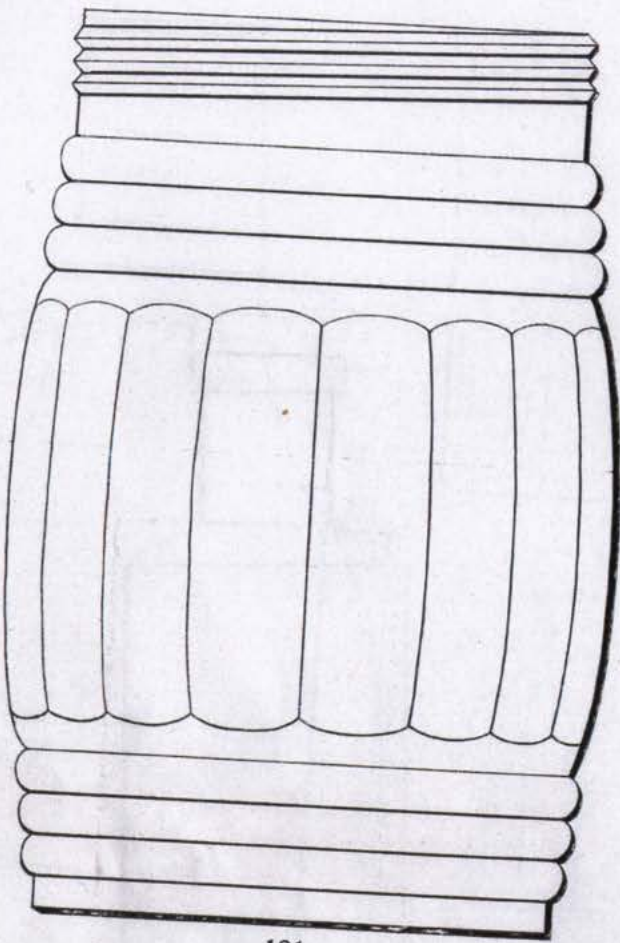

181

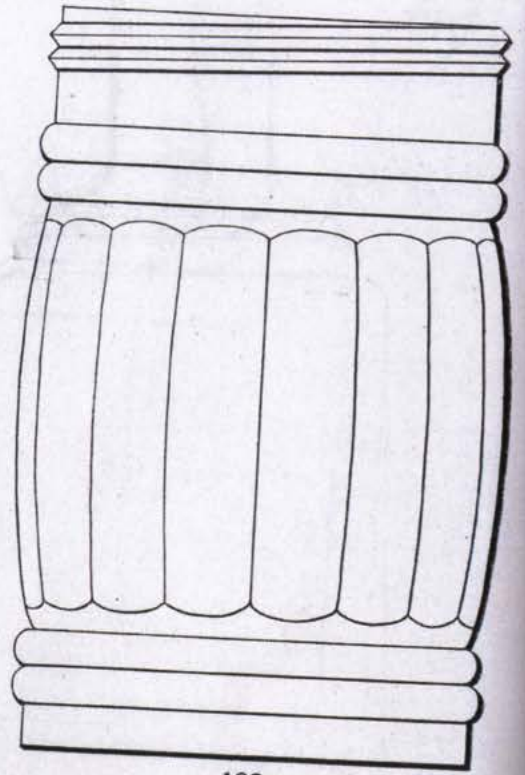

182

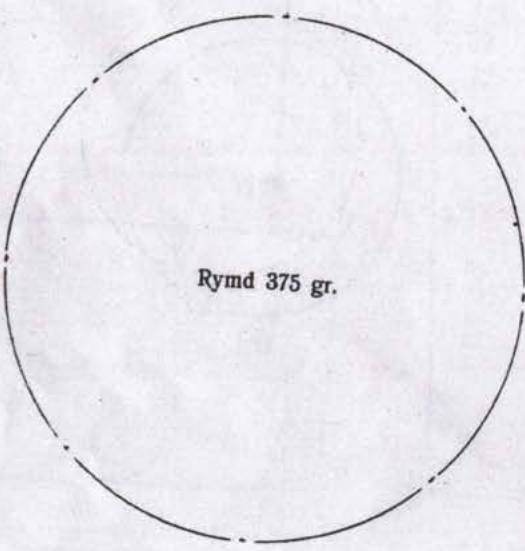

Rymd 375 gr.

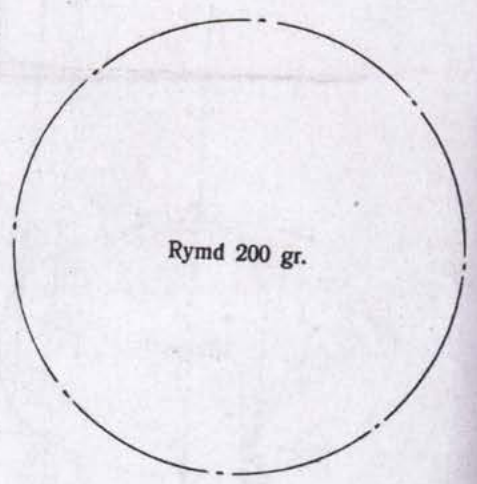

Rymd 200 gr.

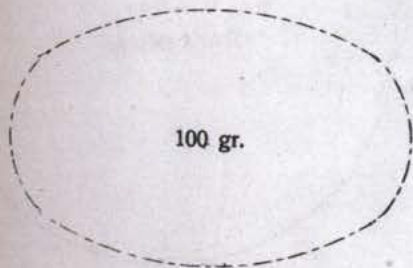
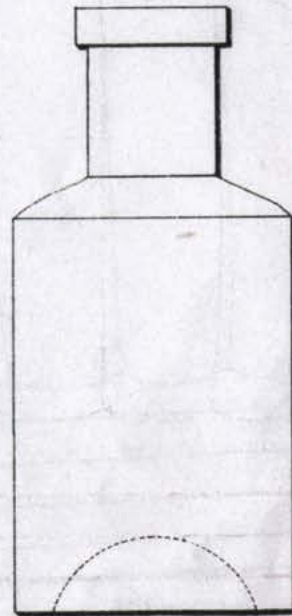
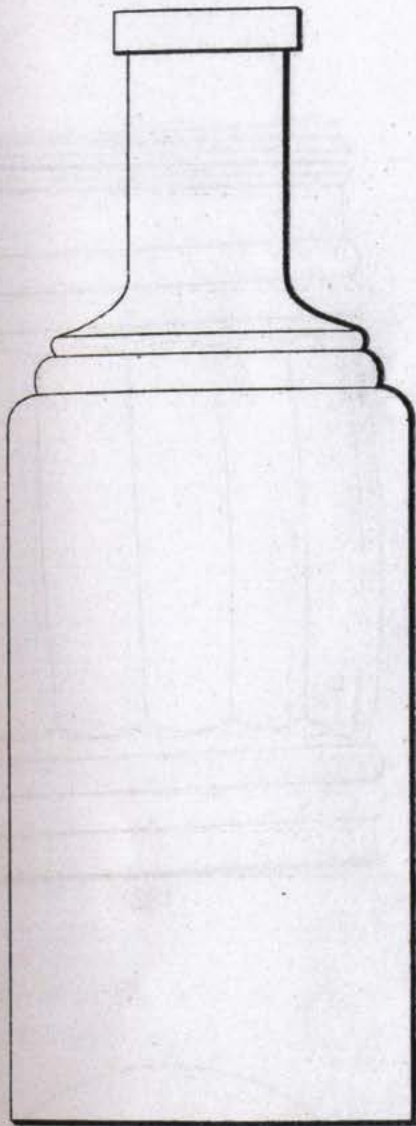

100 gr.

183

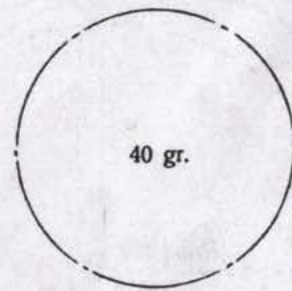

40 gr.

184

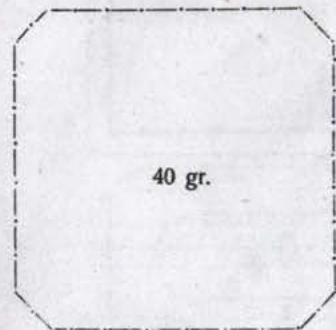
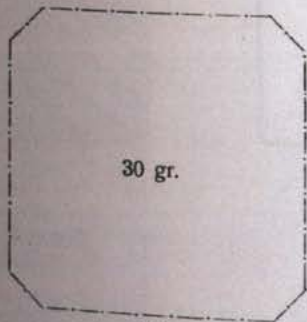
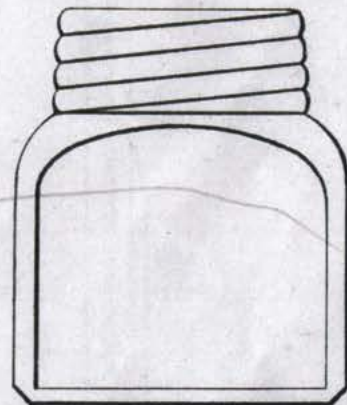
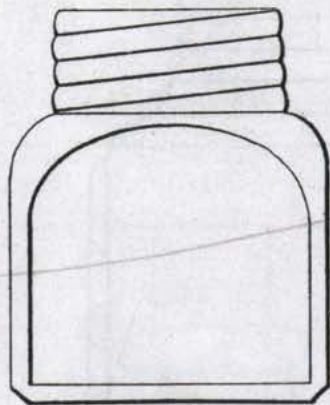
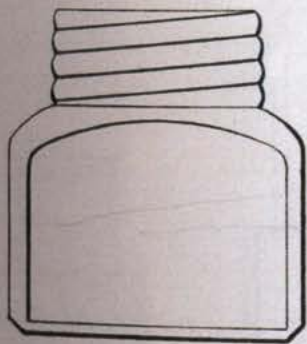
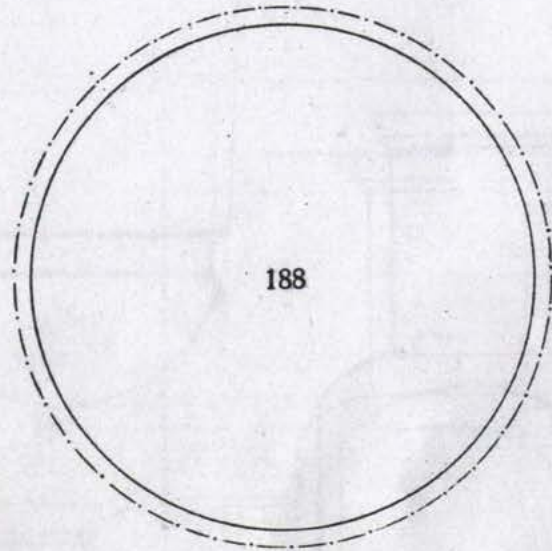
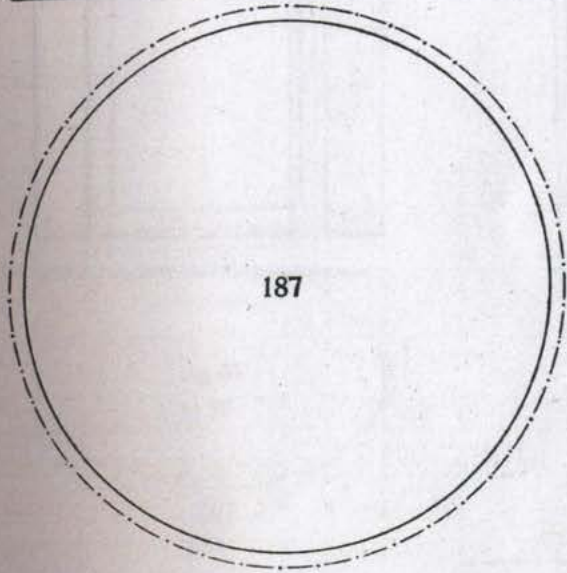
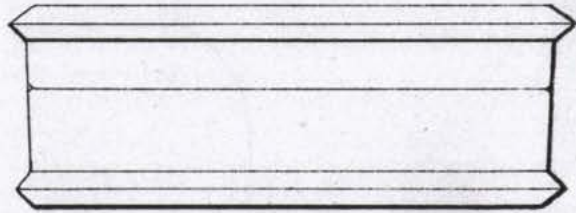
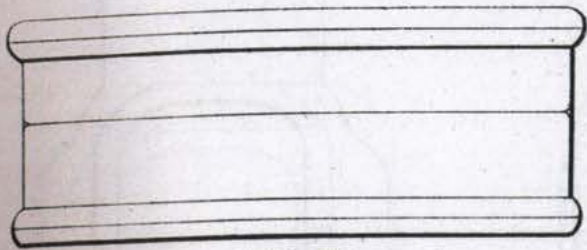

30 gr.

40 gr.

50 gr.

189

190

191

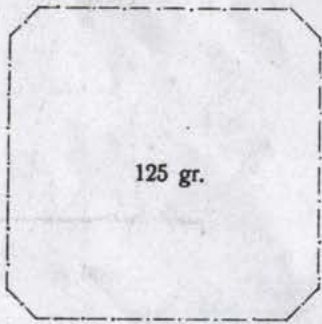
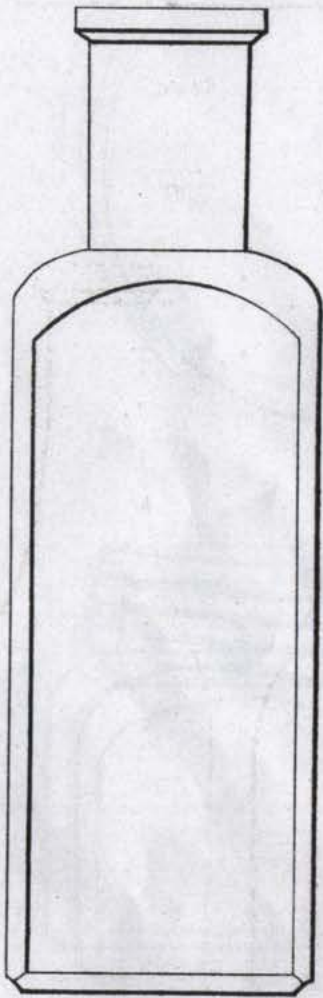

125 gr.

194

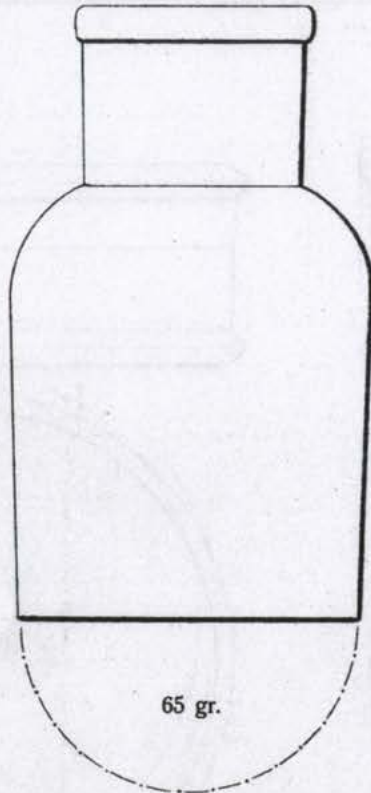

65 gr.

192

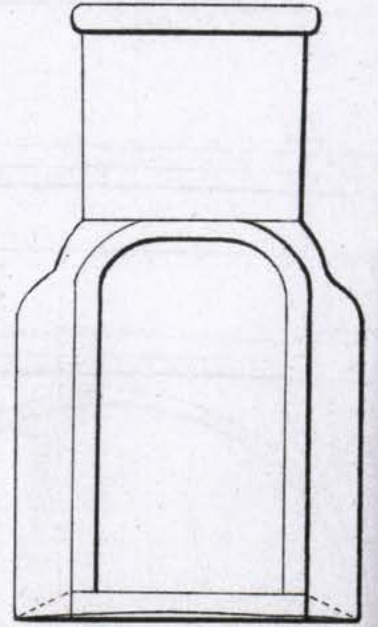

30 gr.

193

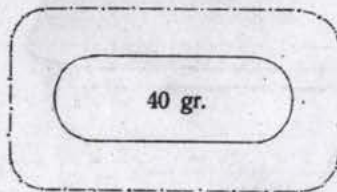

40 gr.

195

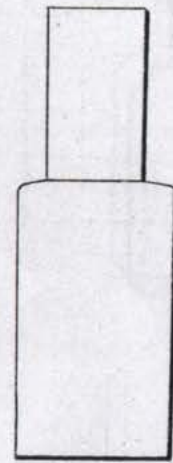

5 gr.

196

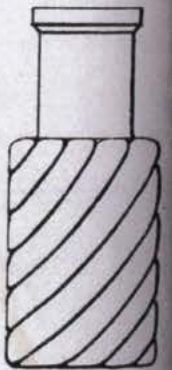

4 gr.

197

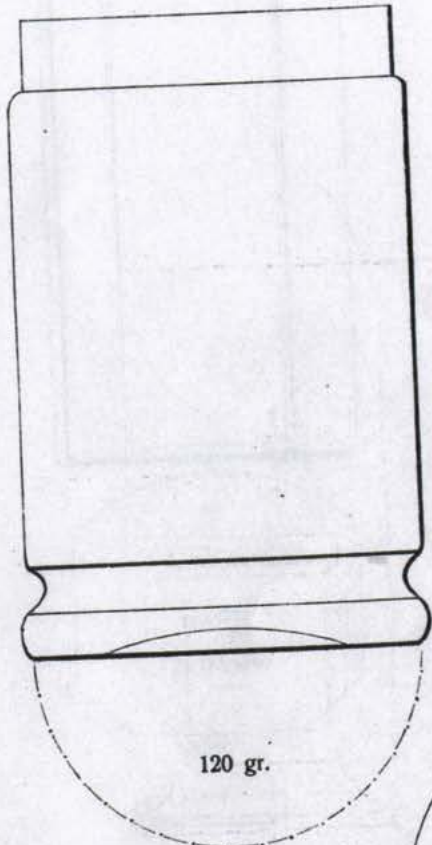
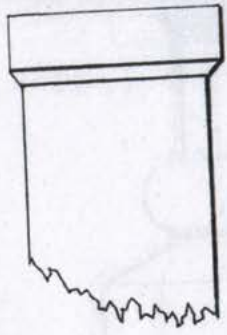
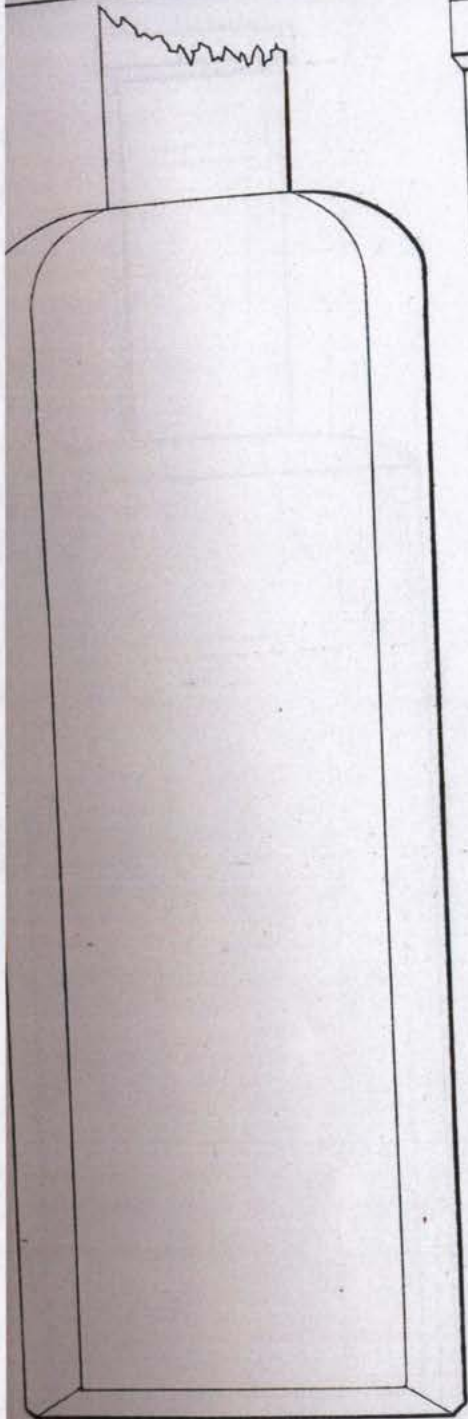

120 gr.

199

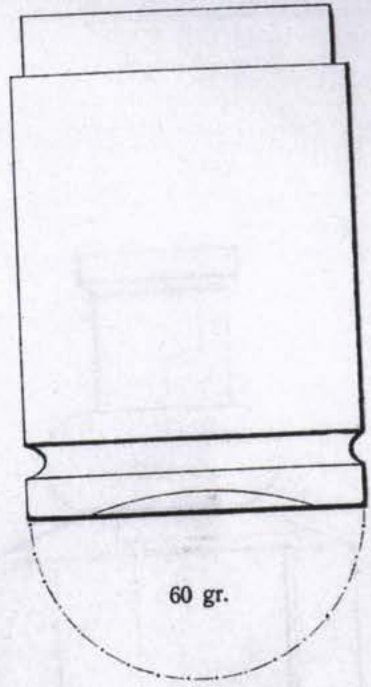

60 gr.

200

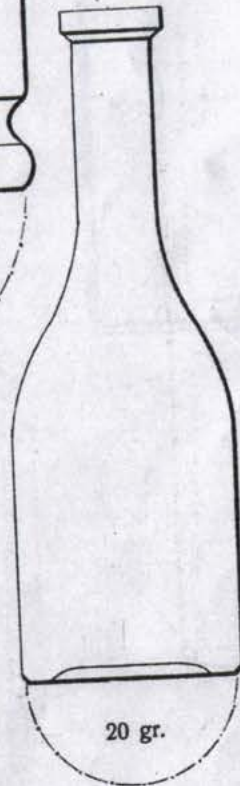

20 gr.

203

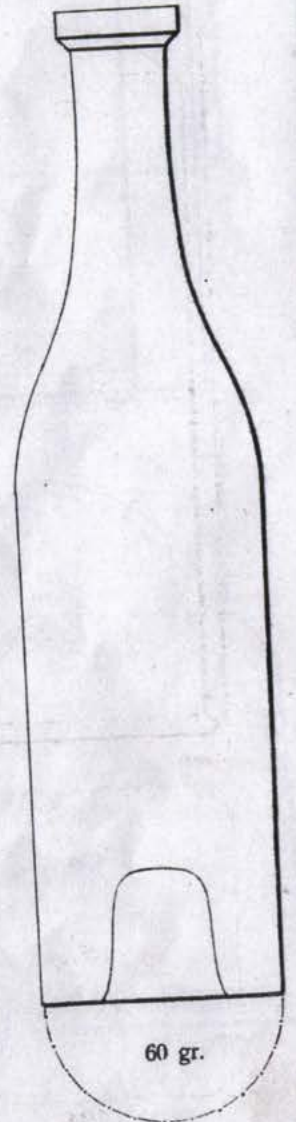

60 gr.

202

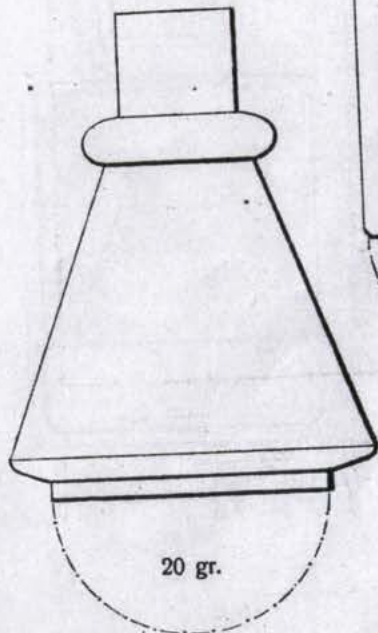

20 gr.

201

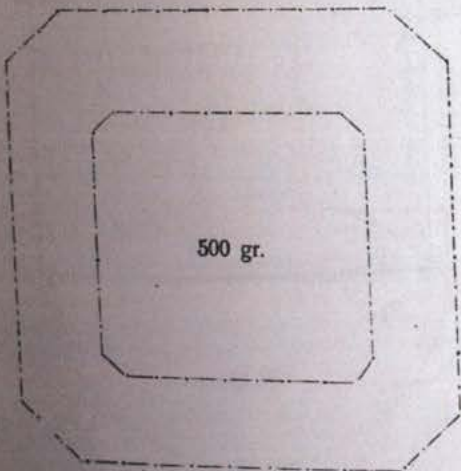

500 gr.

198

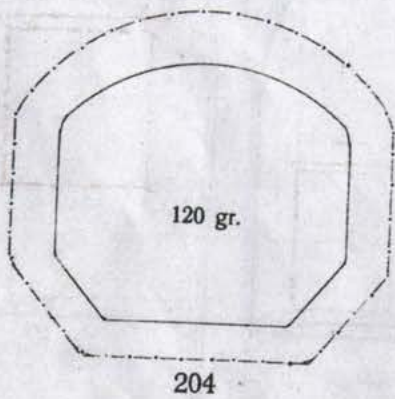
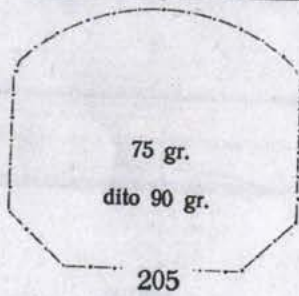
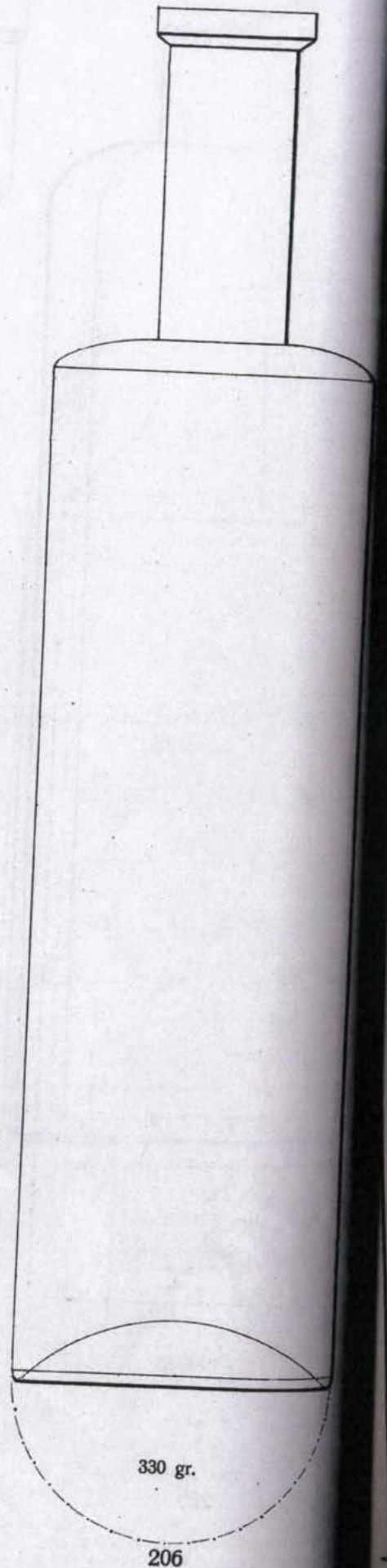
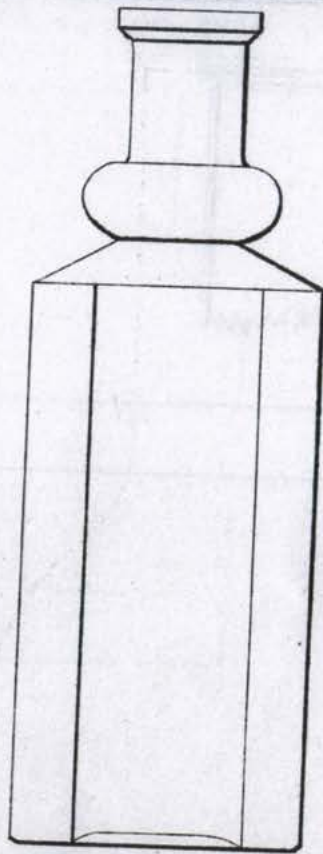
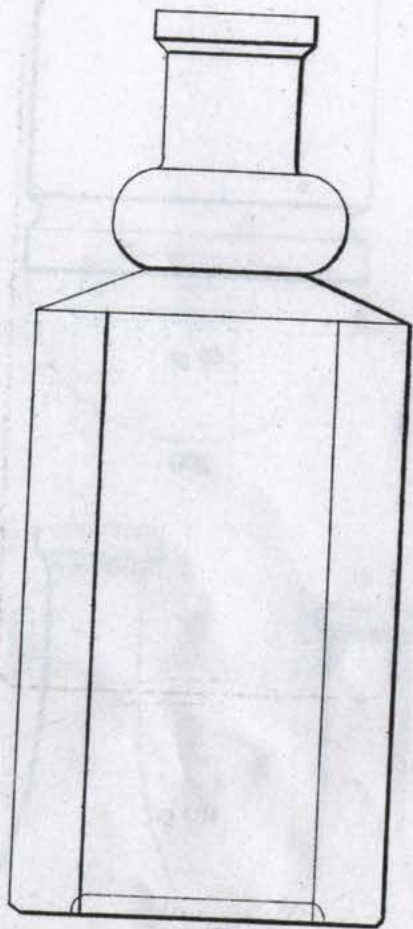

1 dito à 150 gr.

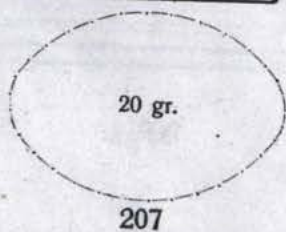
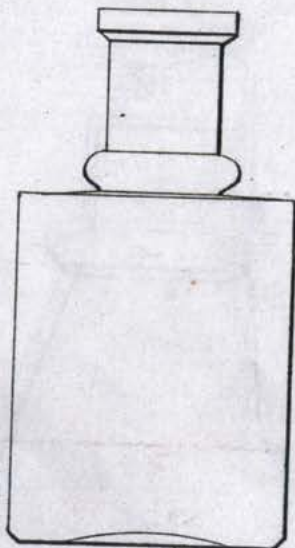

330 gr.

206

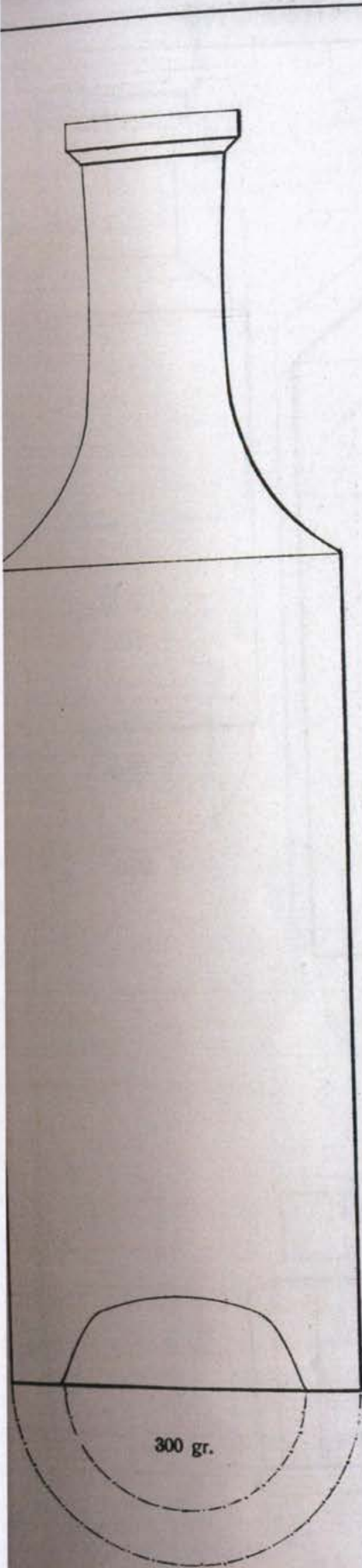

300 gr.

208

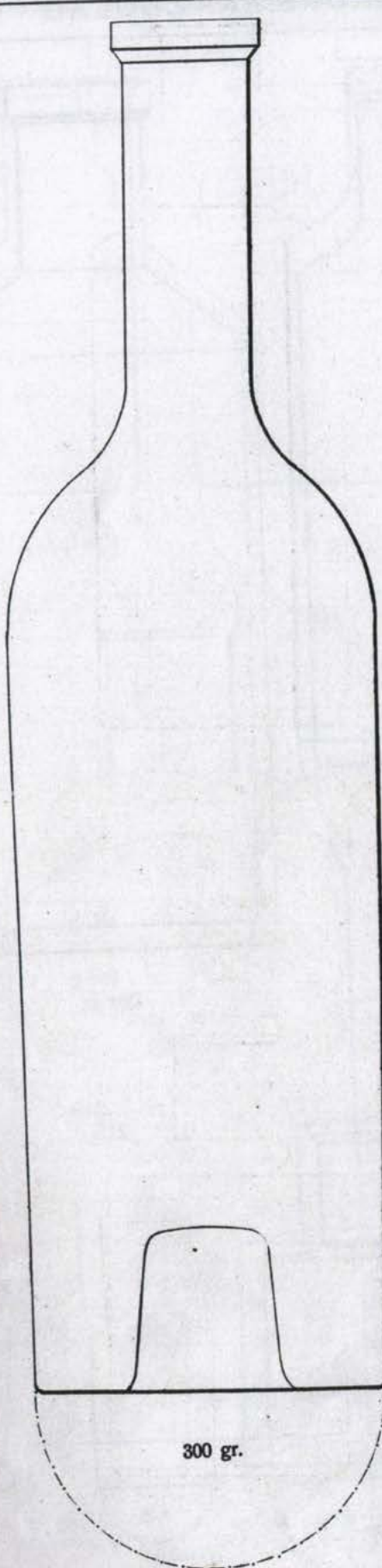

300 gr.

209

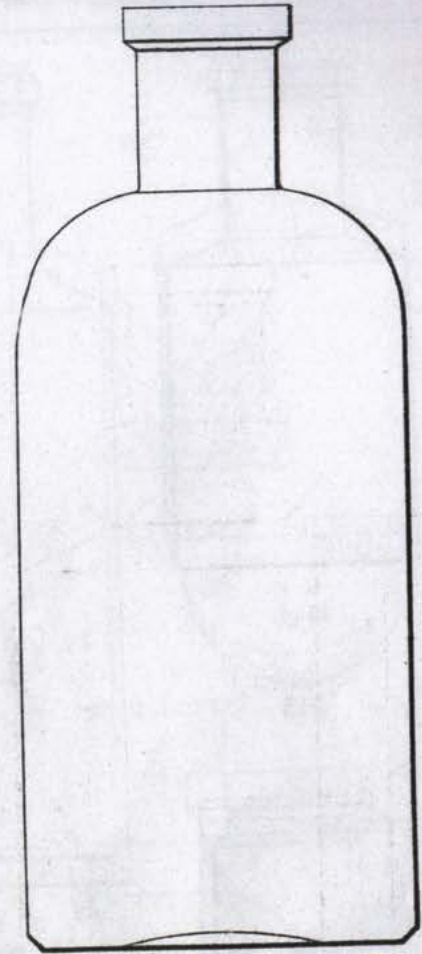

100 gr.

210

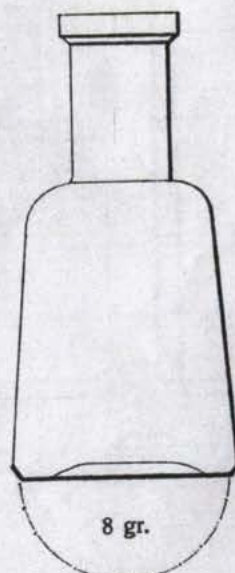

8 gr.

211

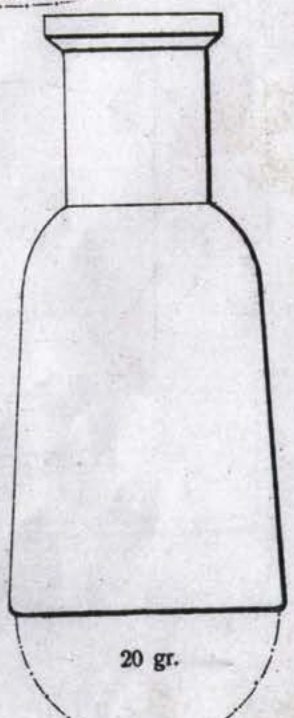

20 gr.

212

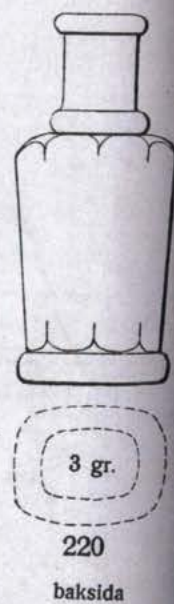
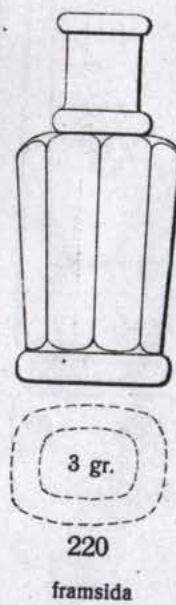
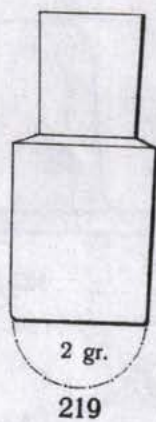
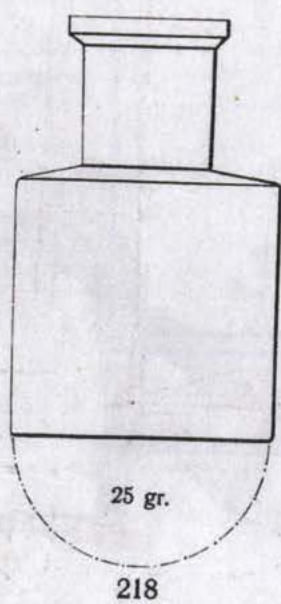
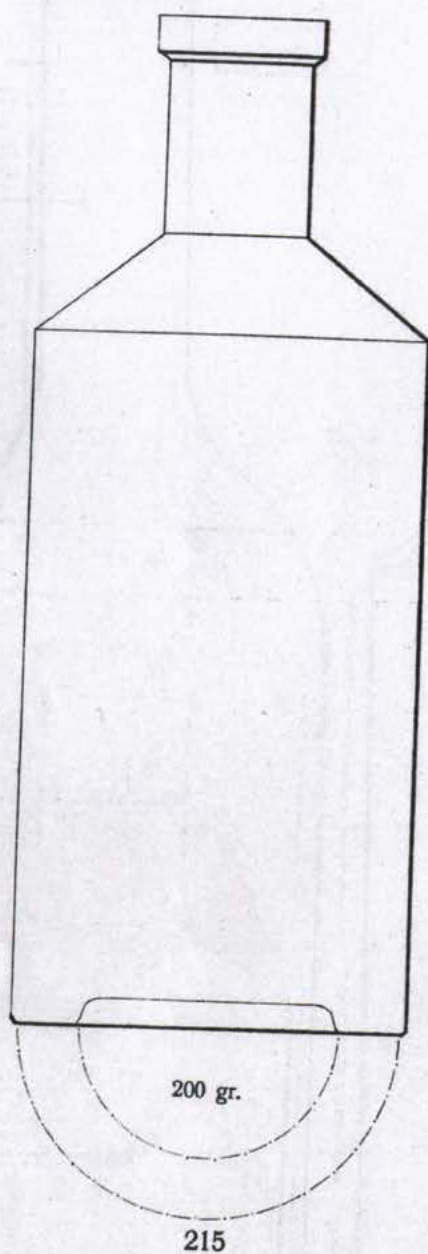
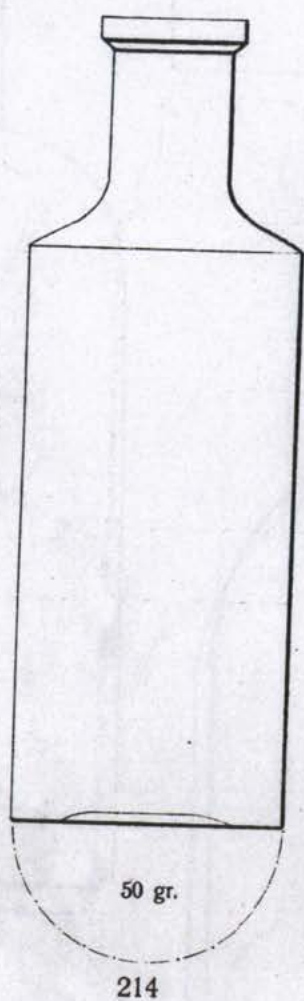
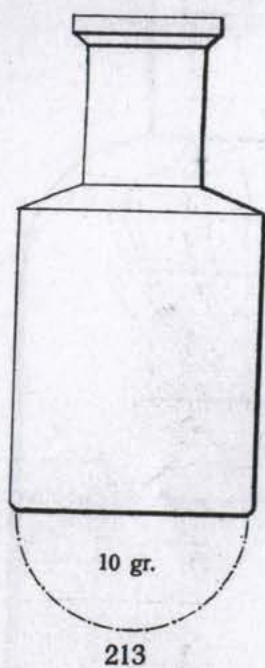

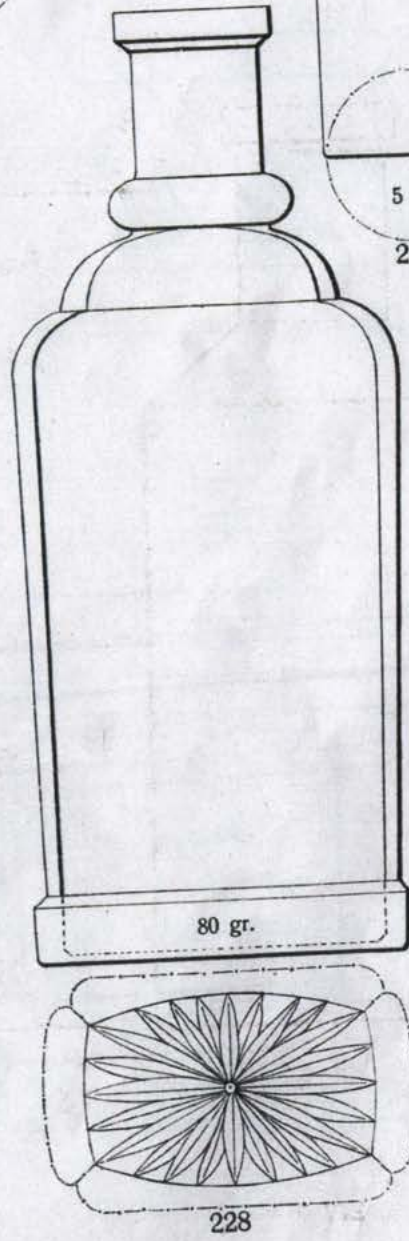
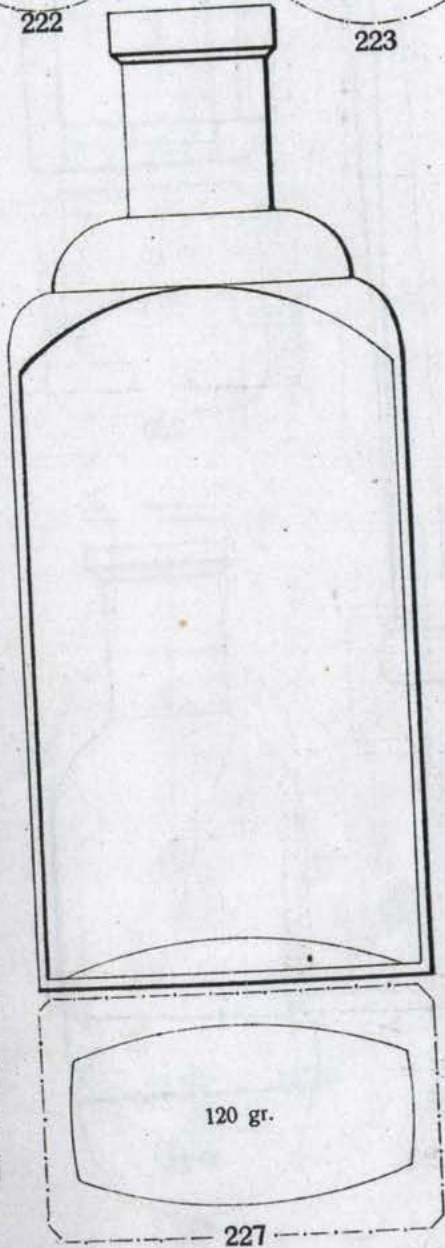
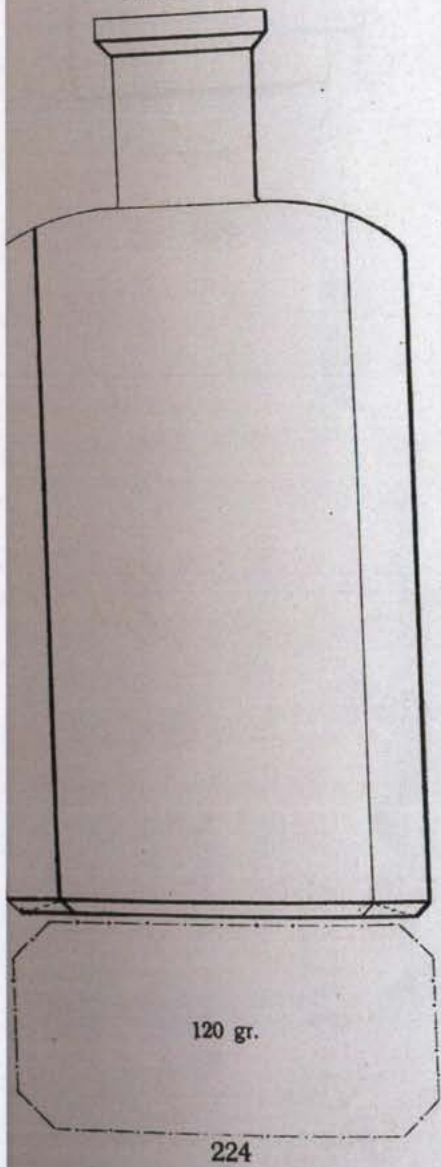
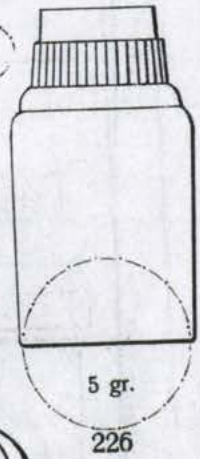
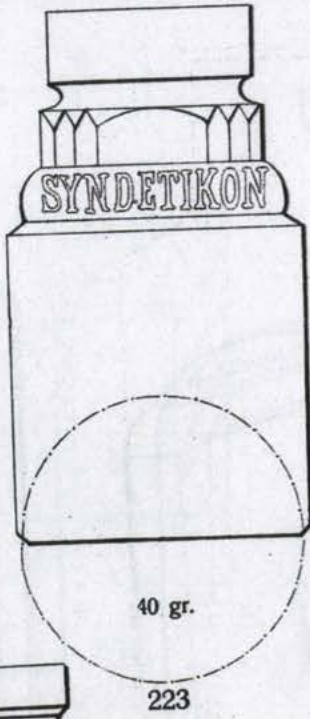
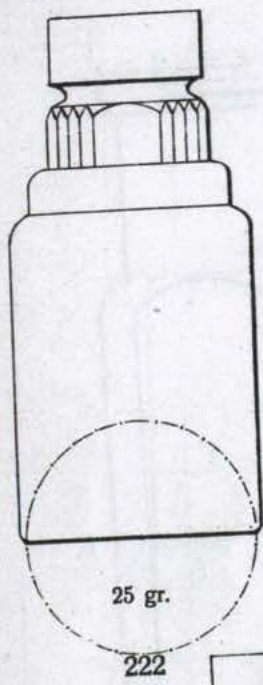
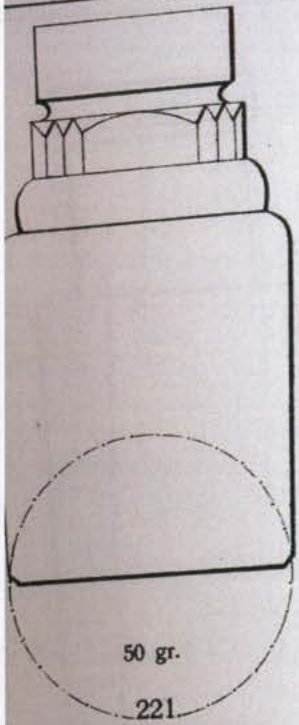

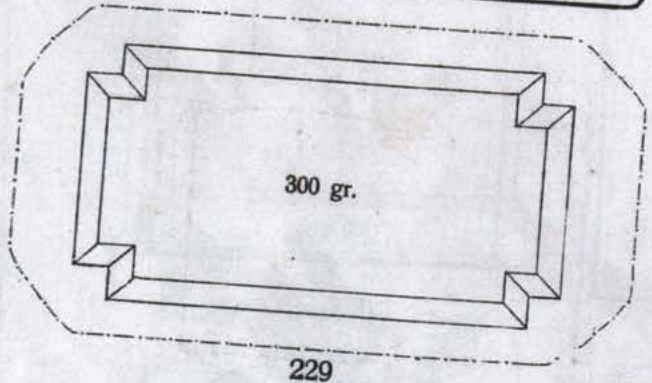
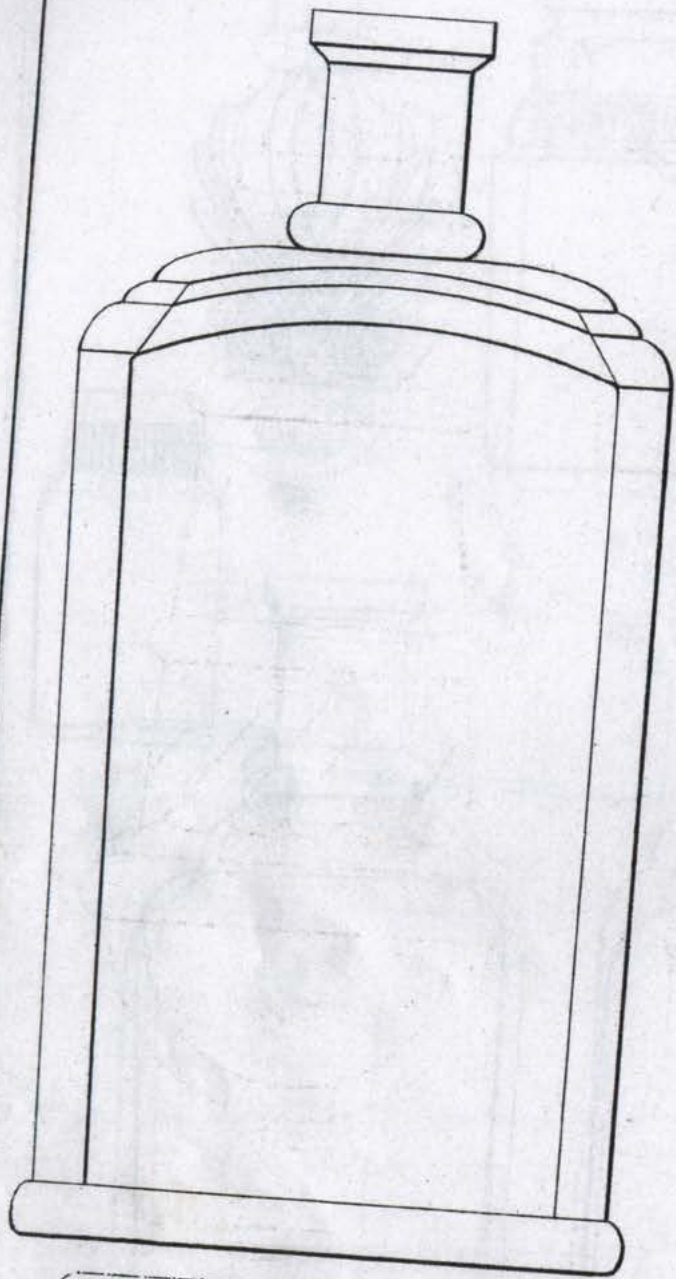

300 gr.

229

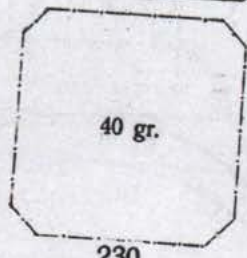
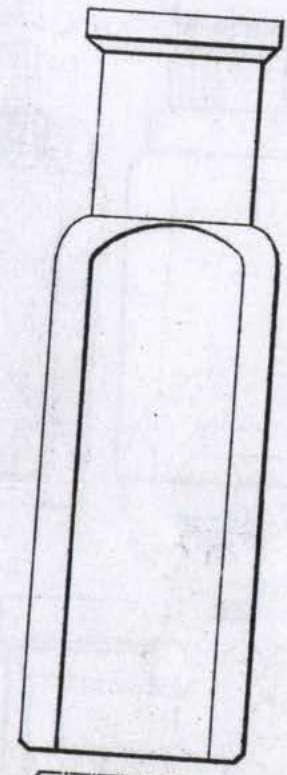

40 gr.

230

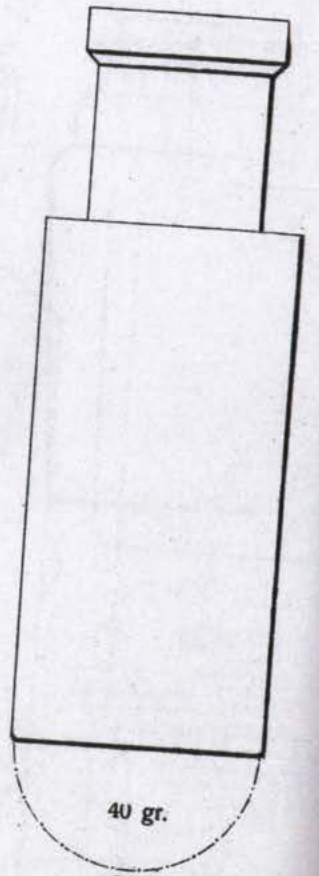

40 gr.

231

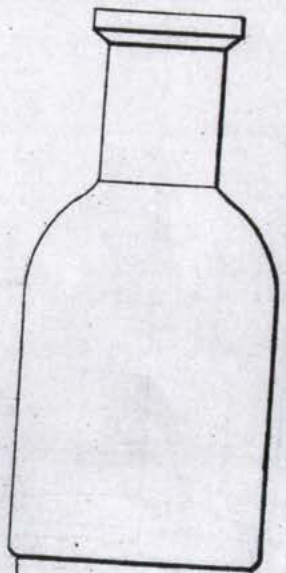

30 gr.

232

233

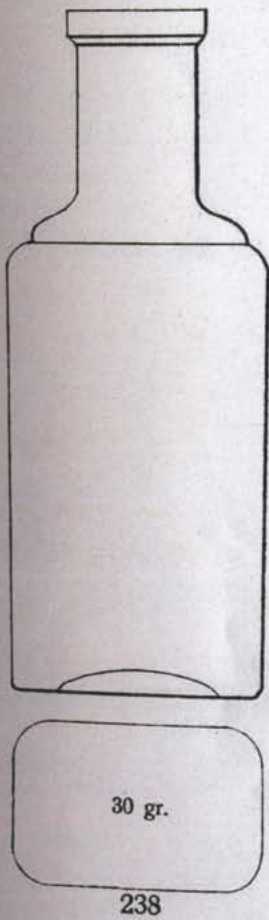
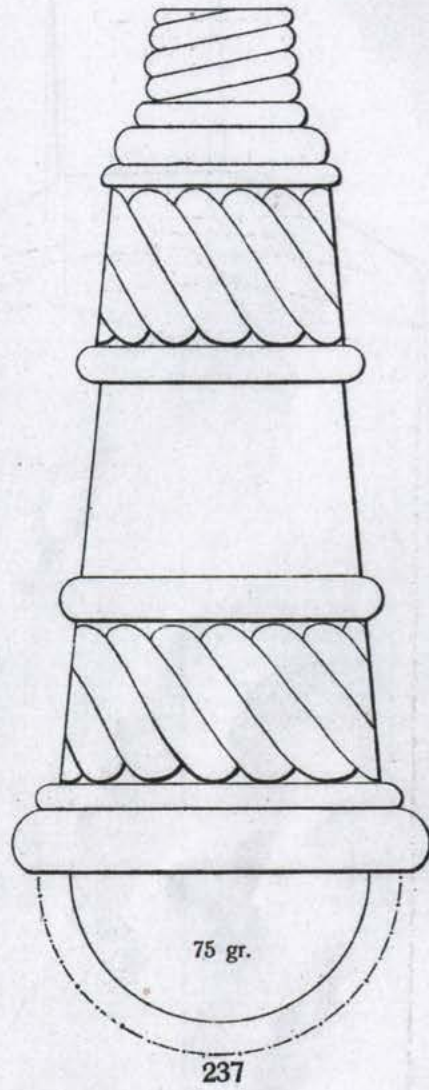
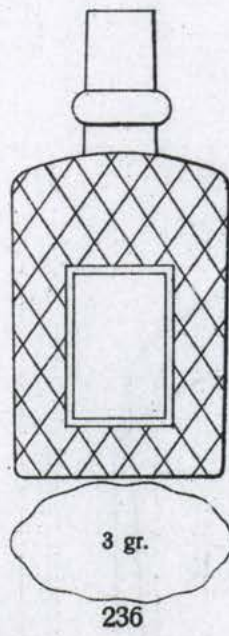
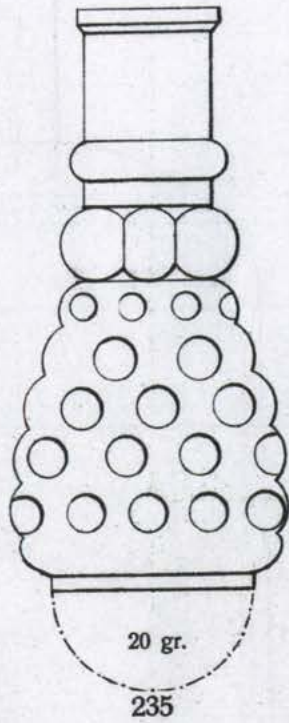
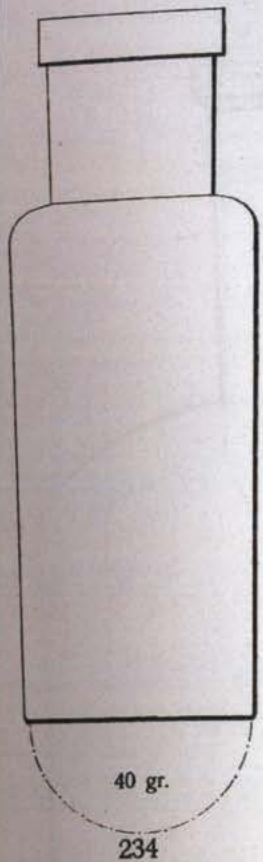

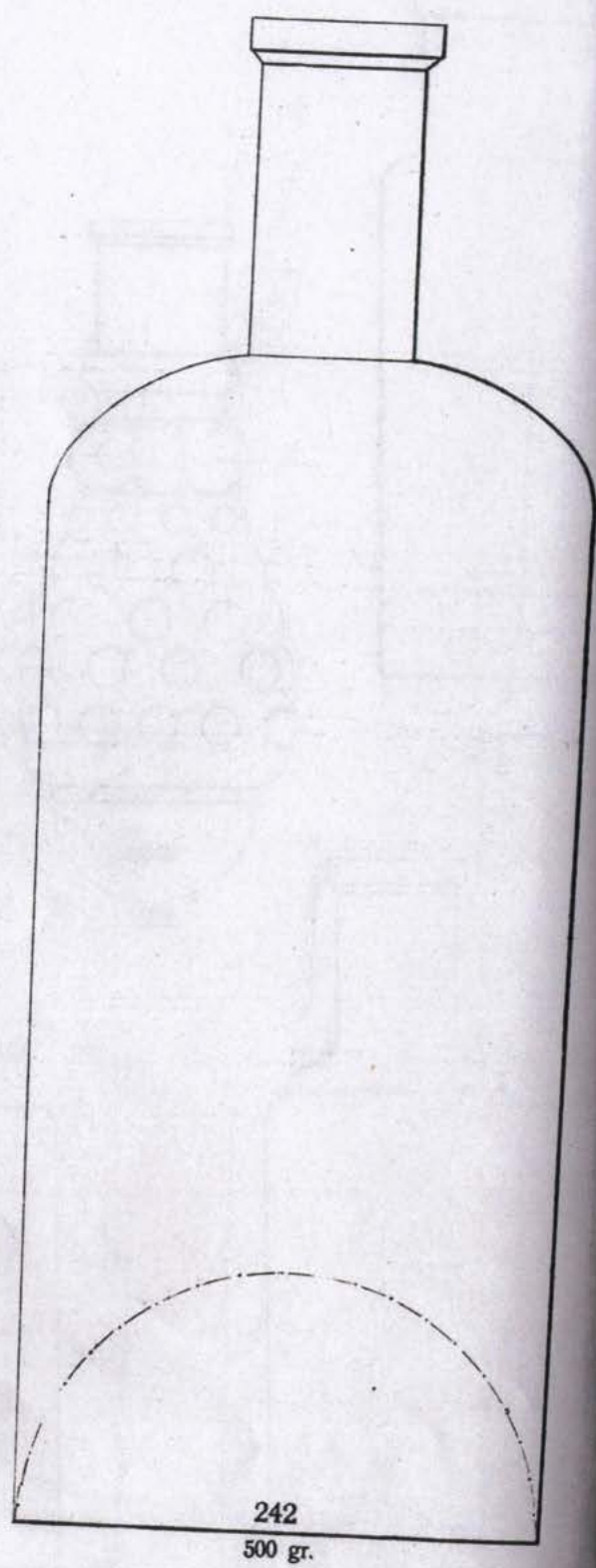
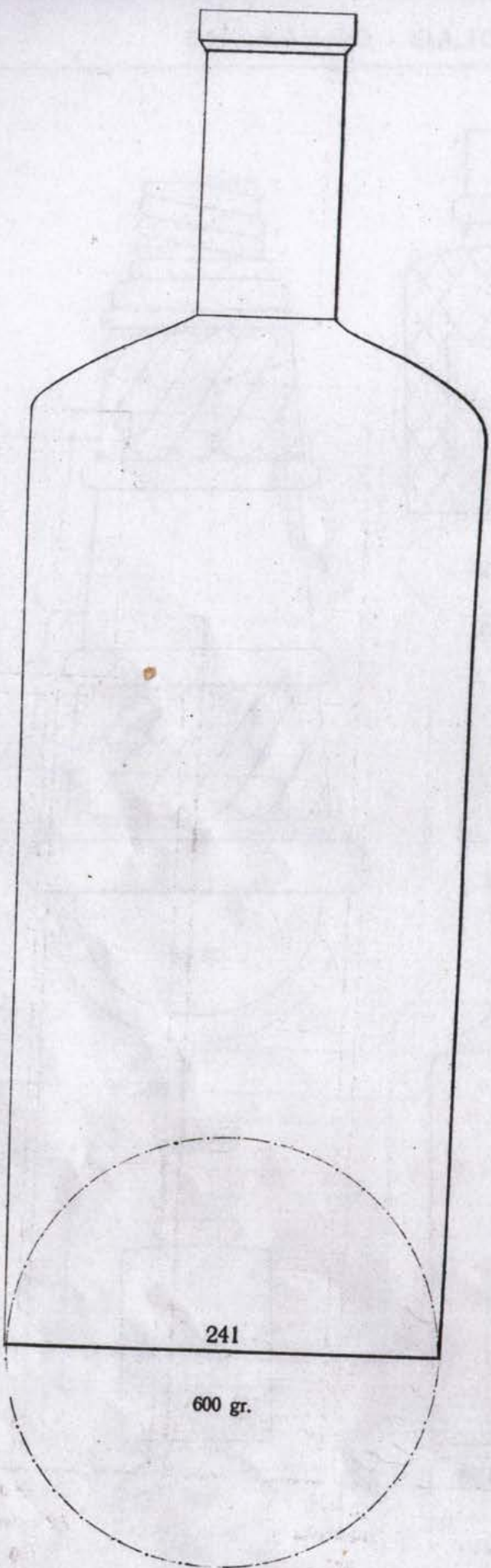

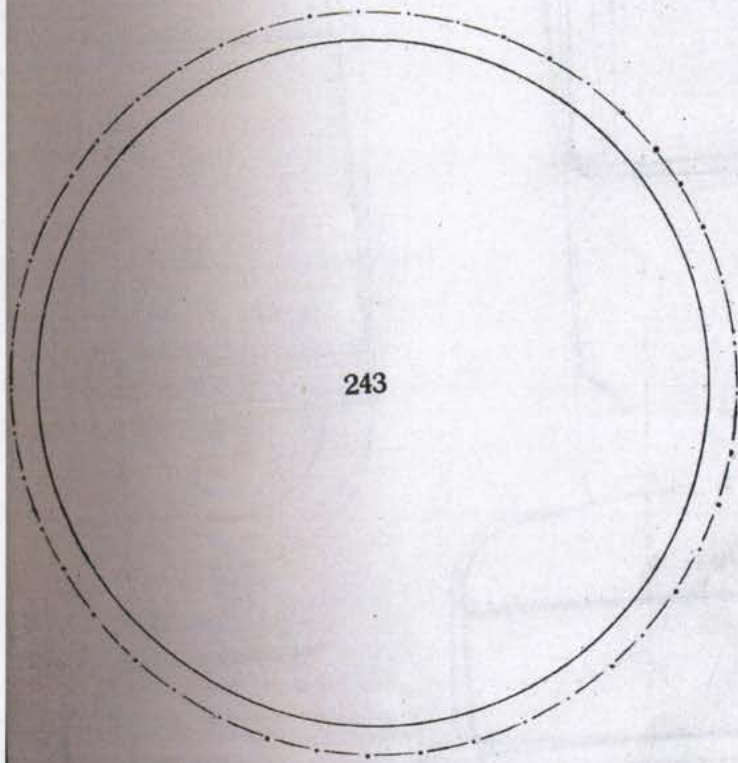
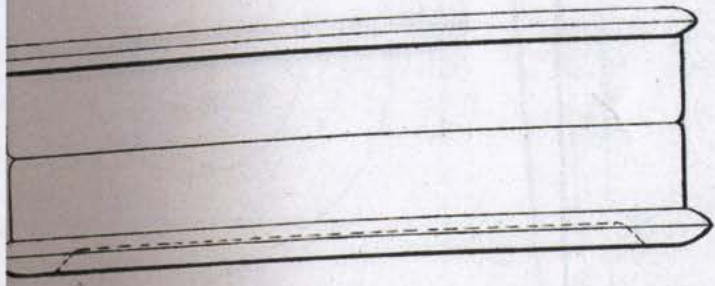

243

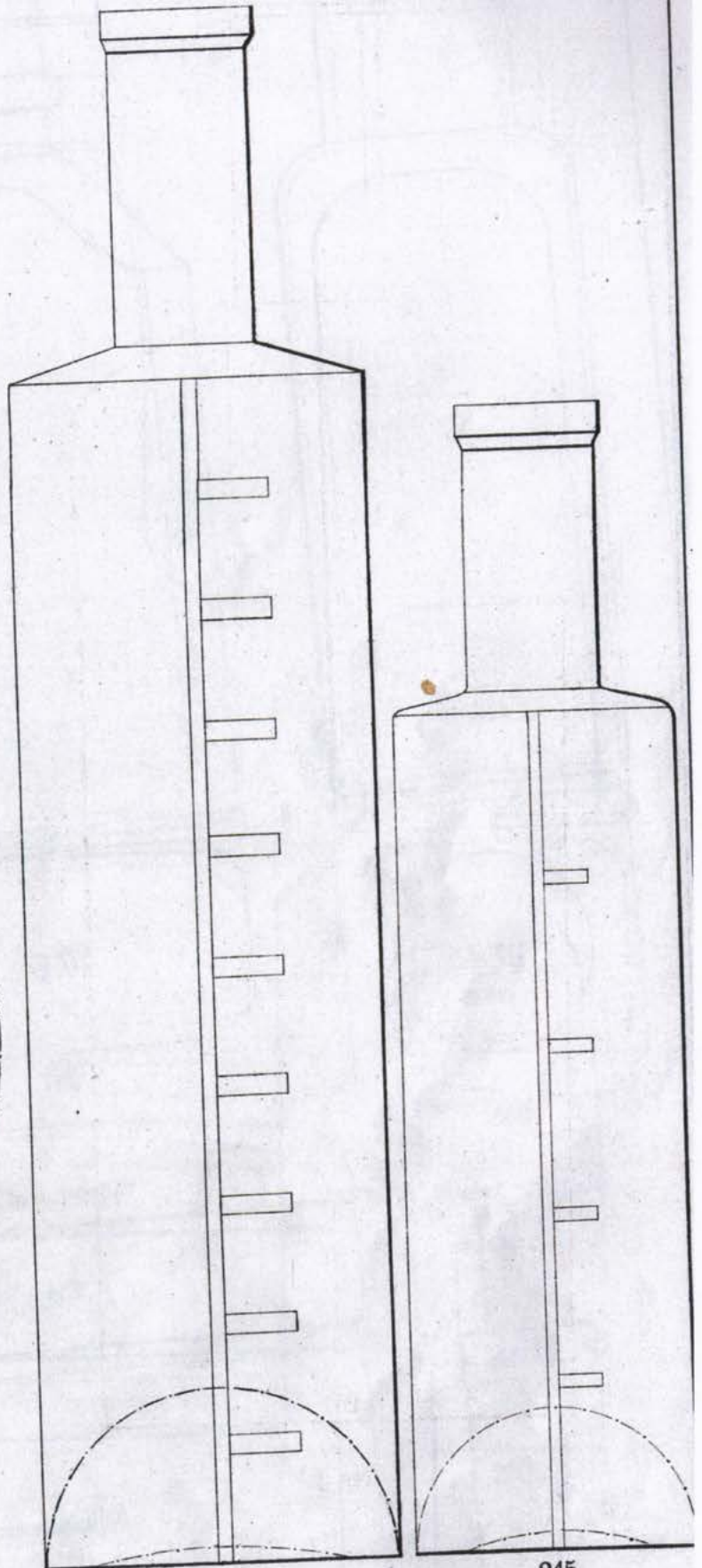

244

Ättiksfaska $\frac{1}{1}$

325 gr.

5/5

245

Ättiksfaska $\frac{1}{2}$

150 gr.

14

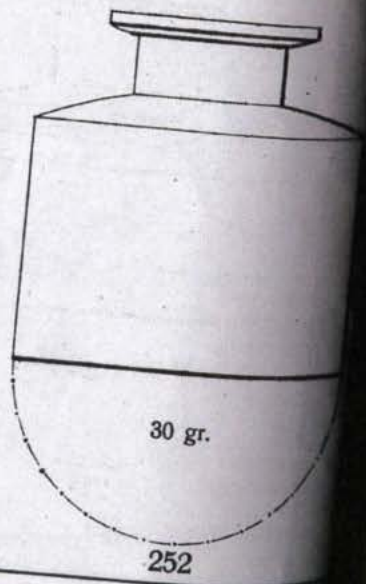
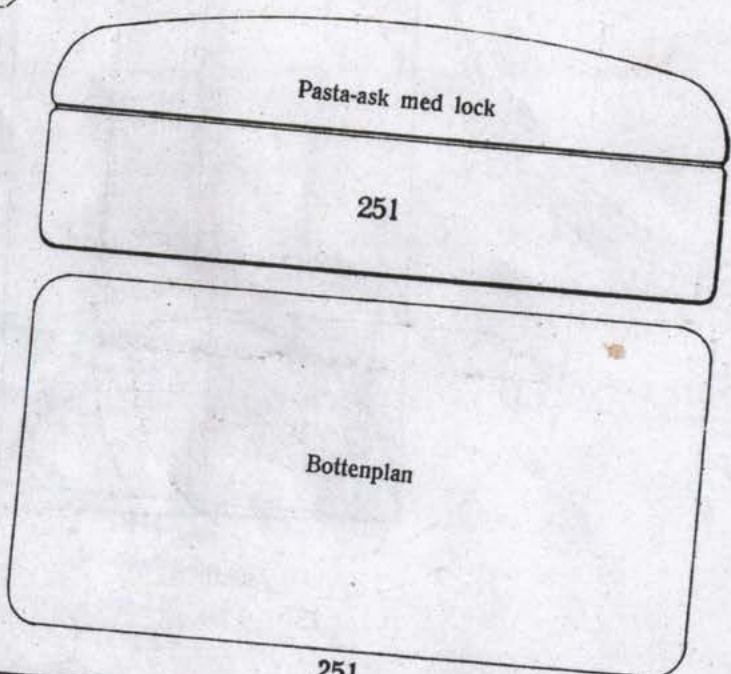
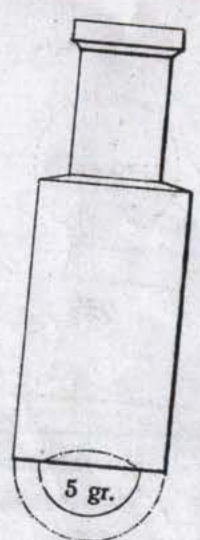
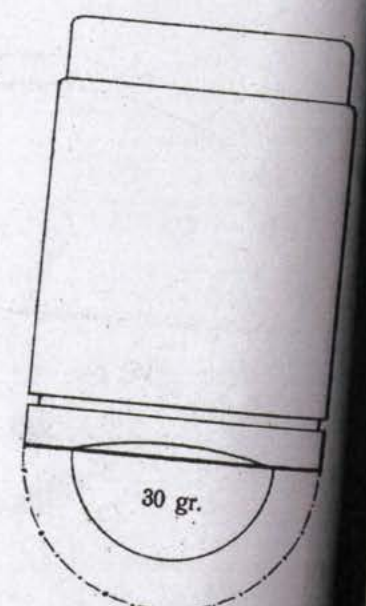
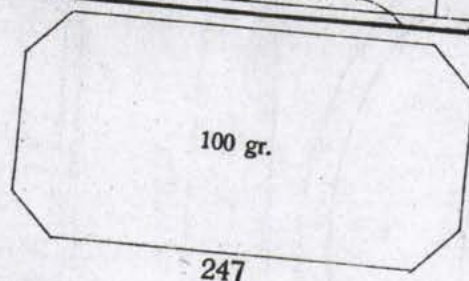
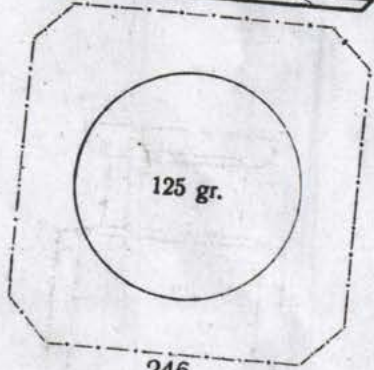
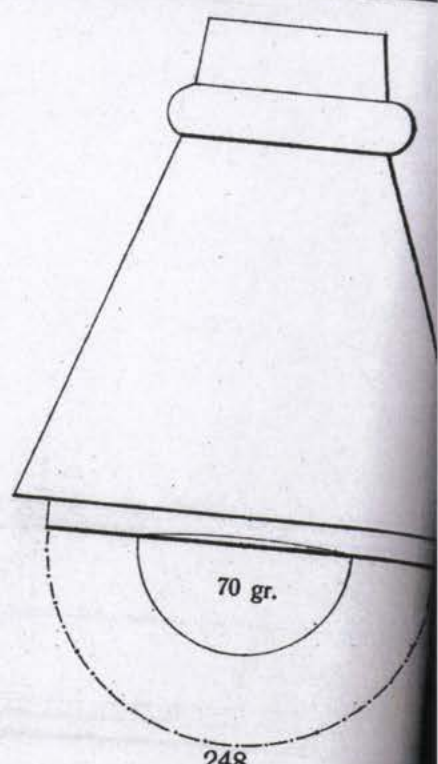
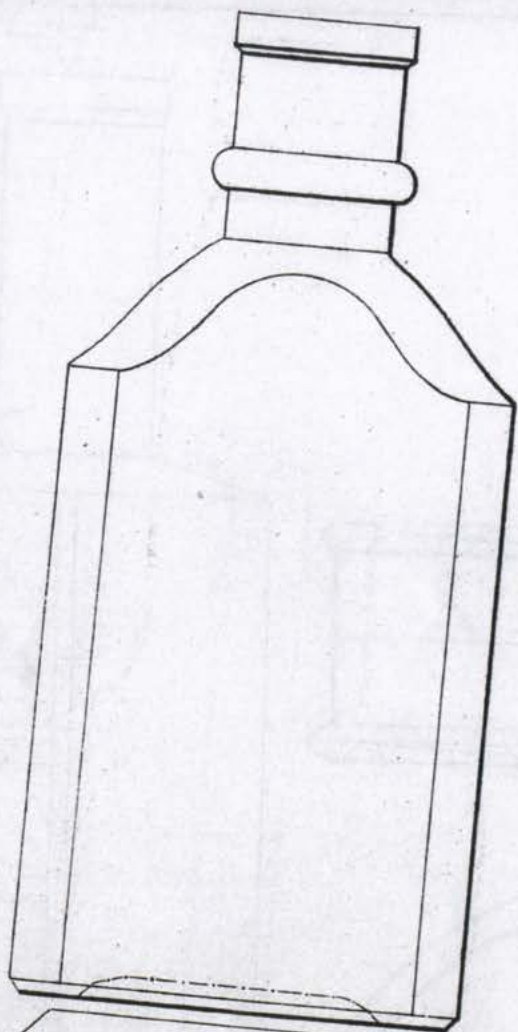
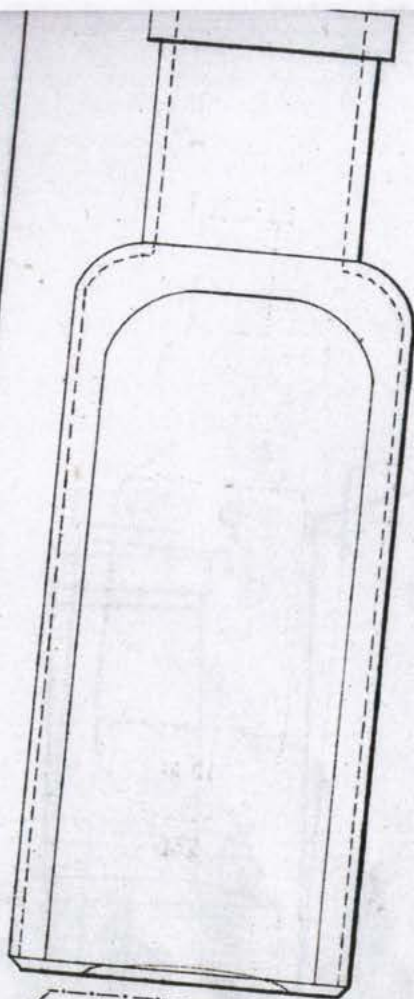

125 gr.

100 gr.

70 gr.

246

247

249

Pasta-ask med lock

251

Bottenplan

5 gr.

30 gr.

30 gr.

250

251

252

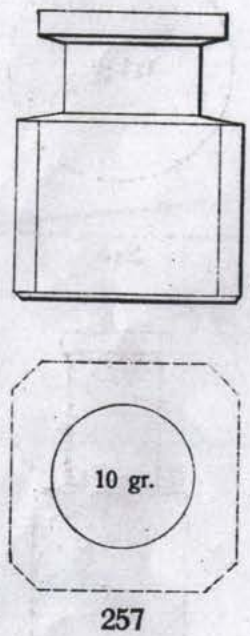
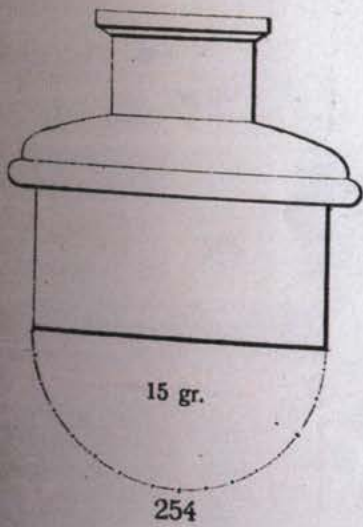
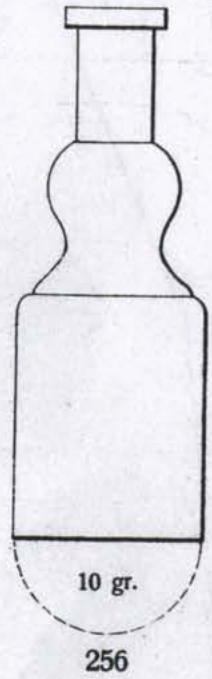
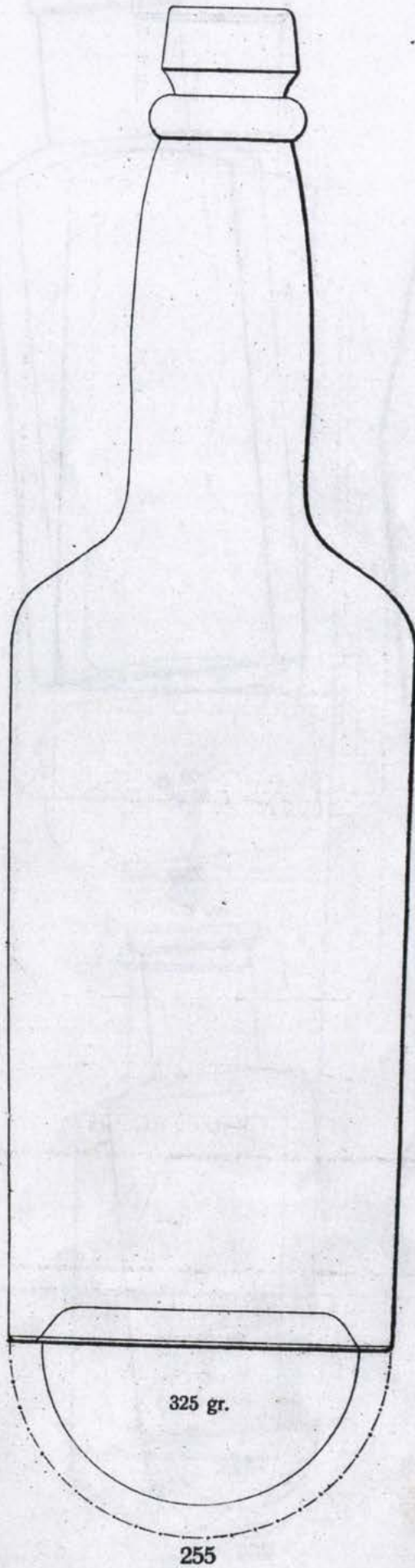
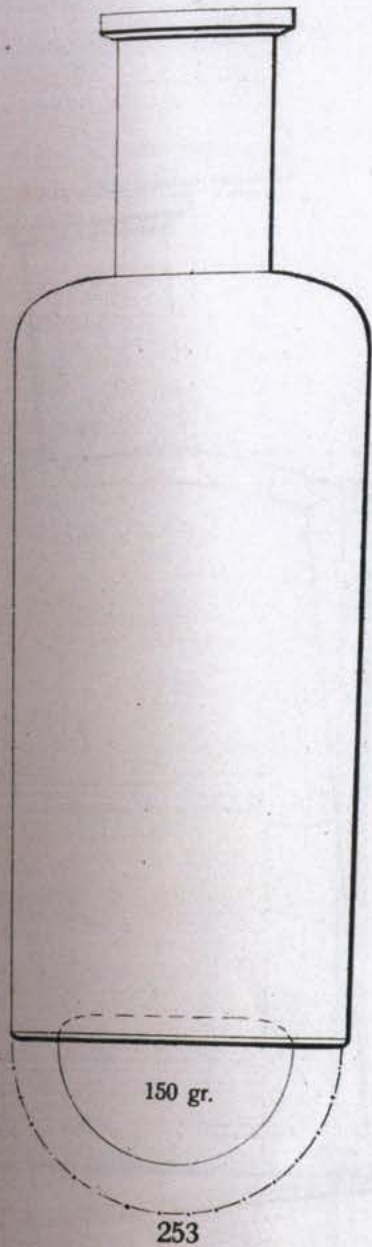

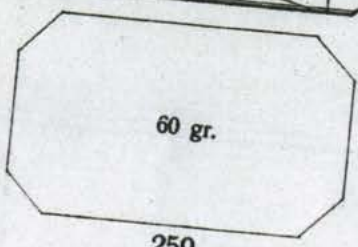
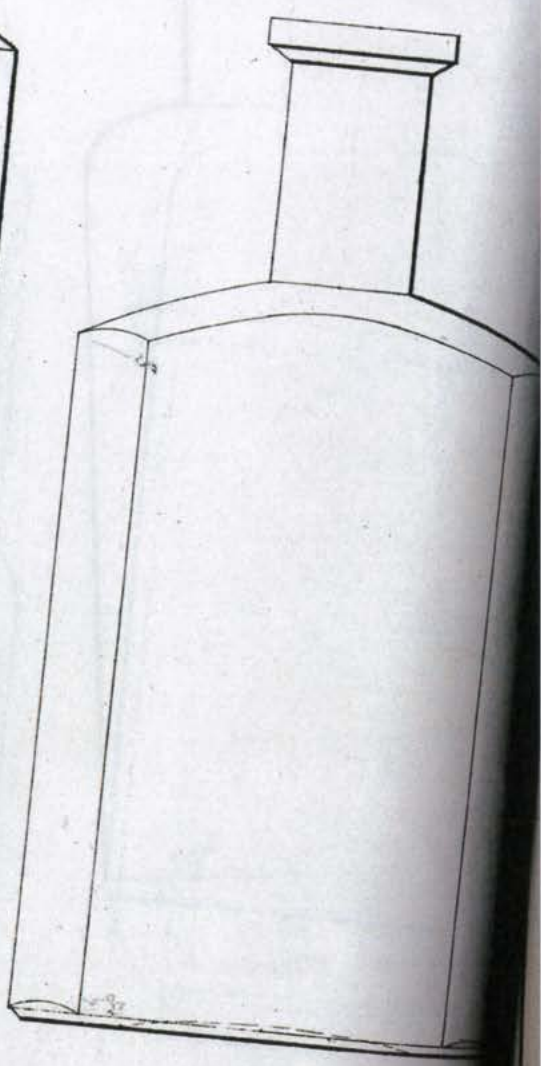
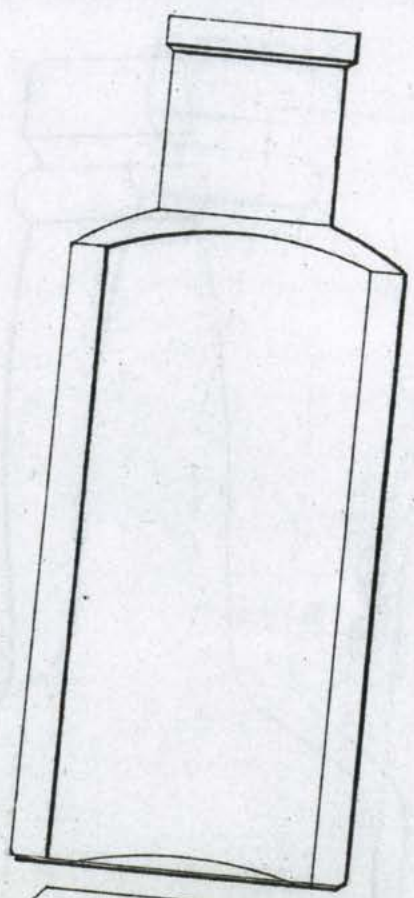
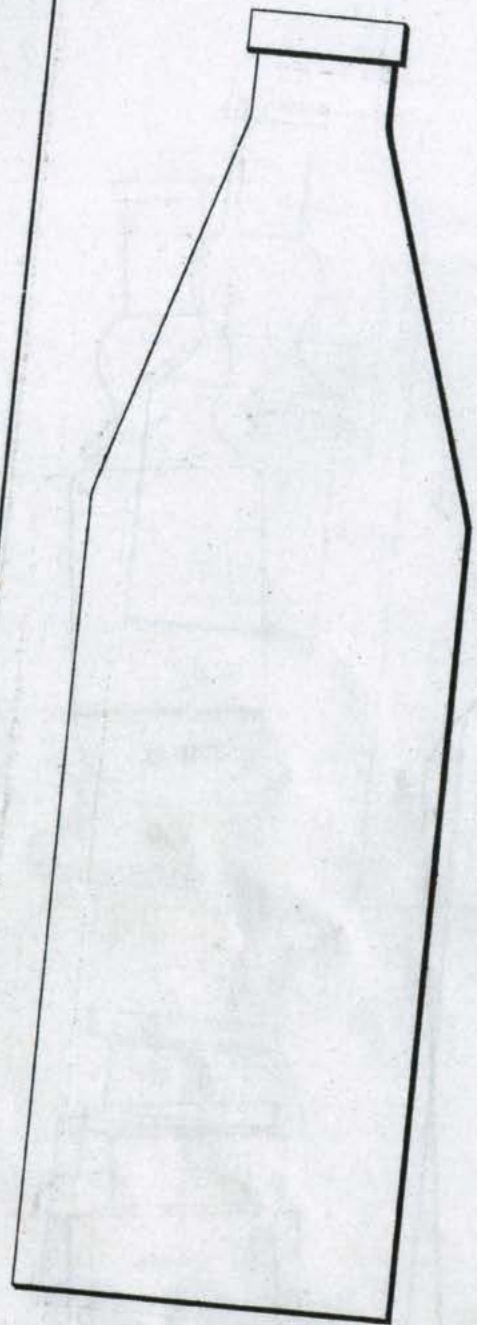

259

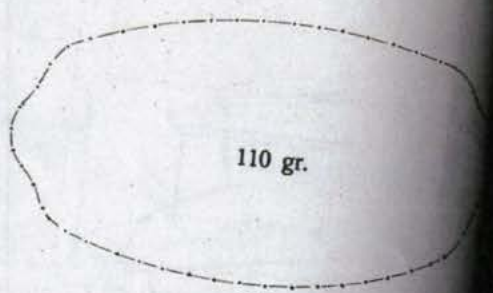
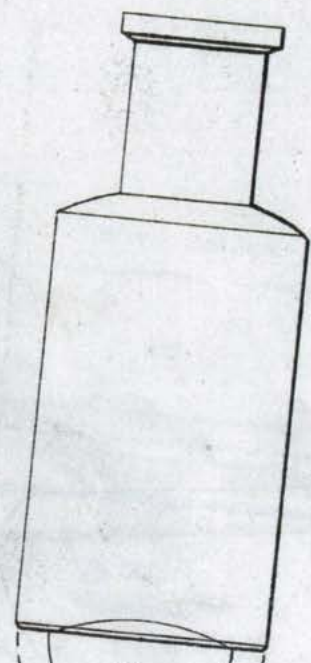

261

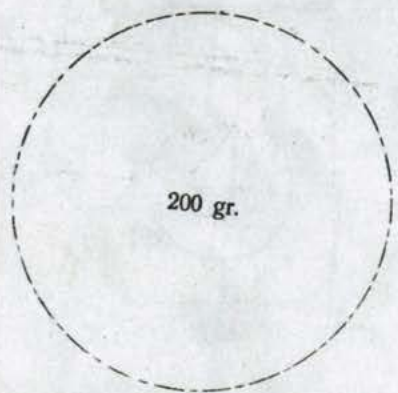

258

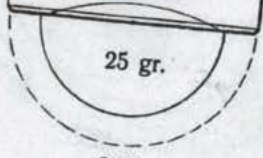

260

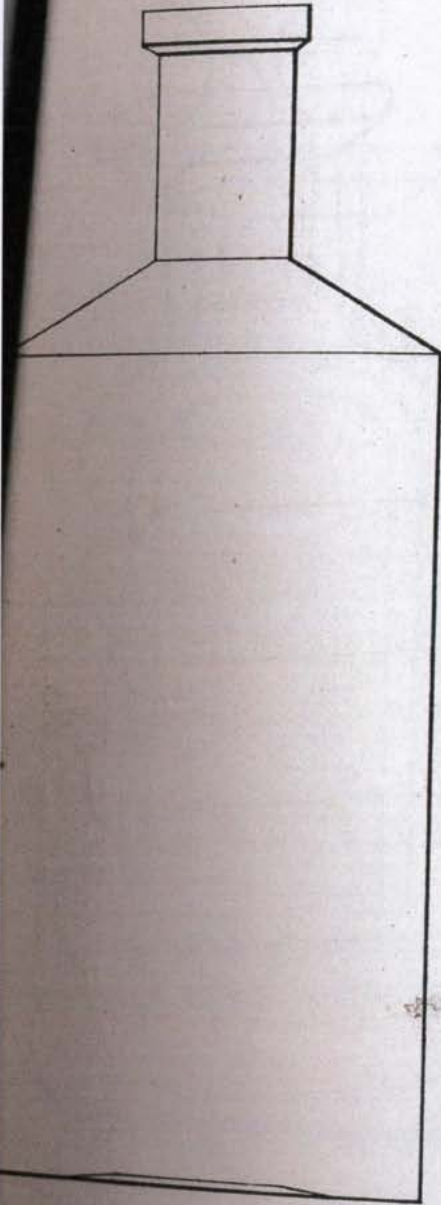

150 gr.

262

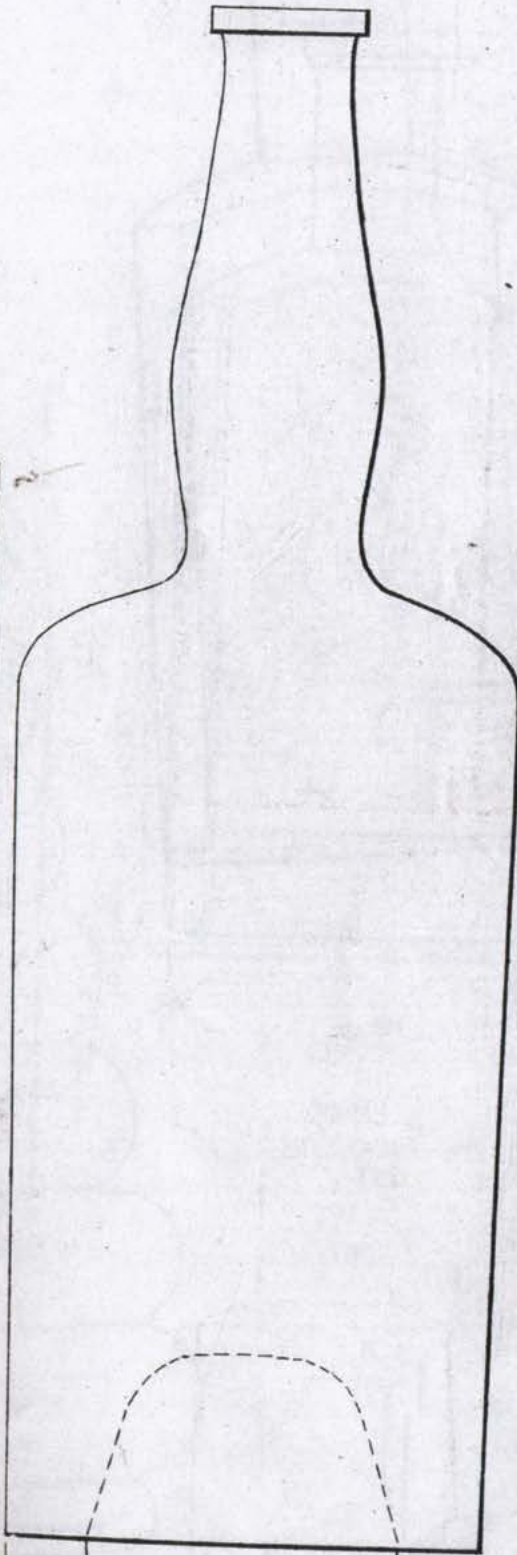

300 gr.

263

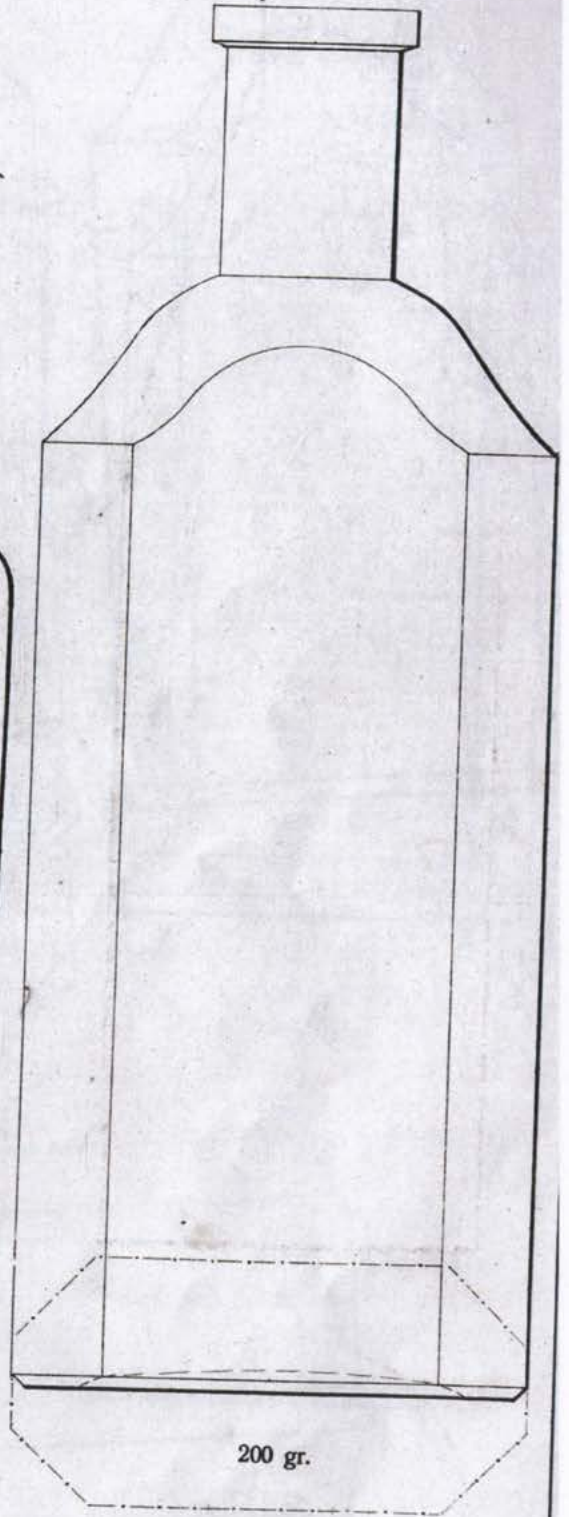

200 gr.

264

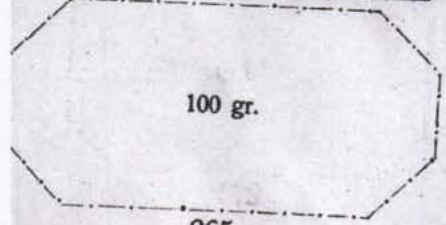
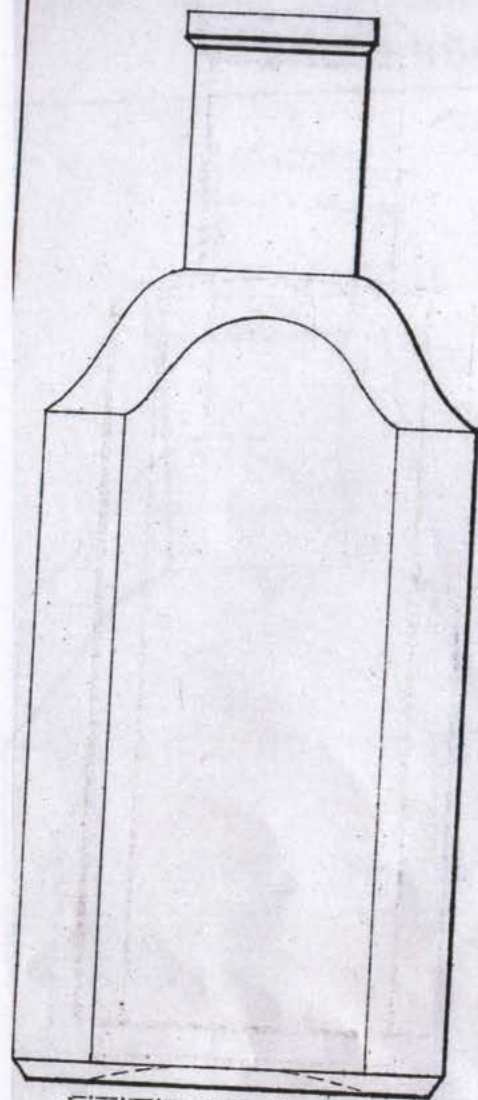

100 gr.

265

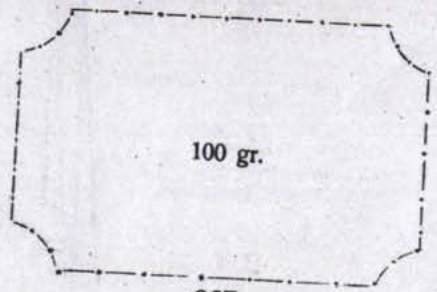
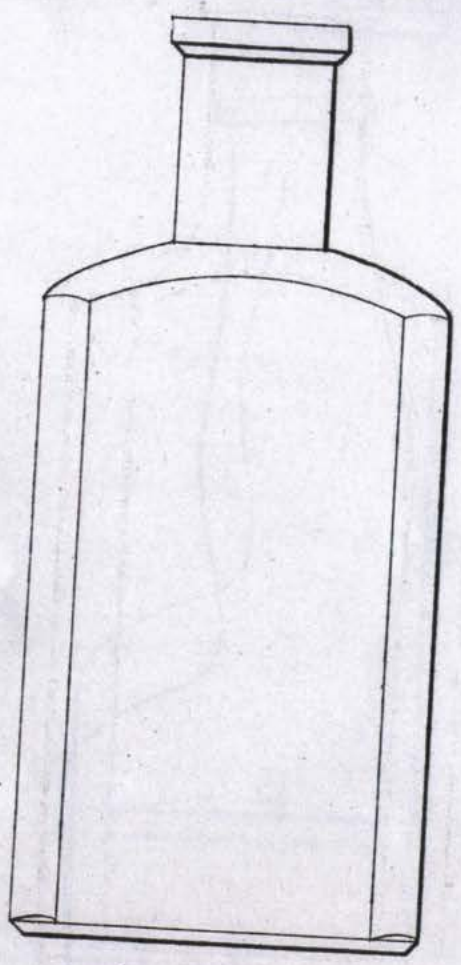

100 gr.

267

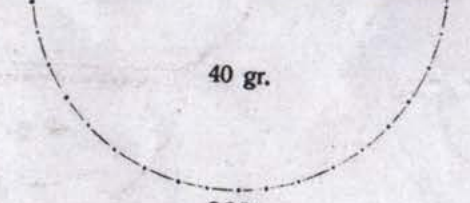
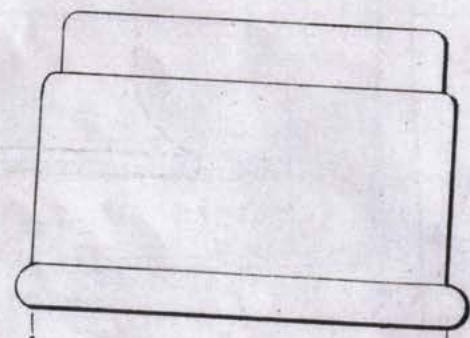

40 gr.

266

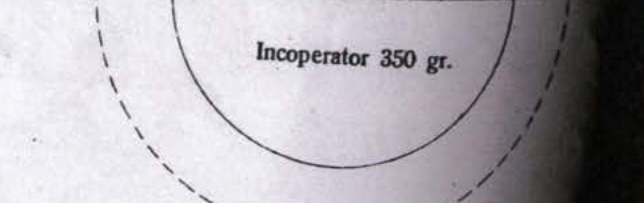
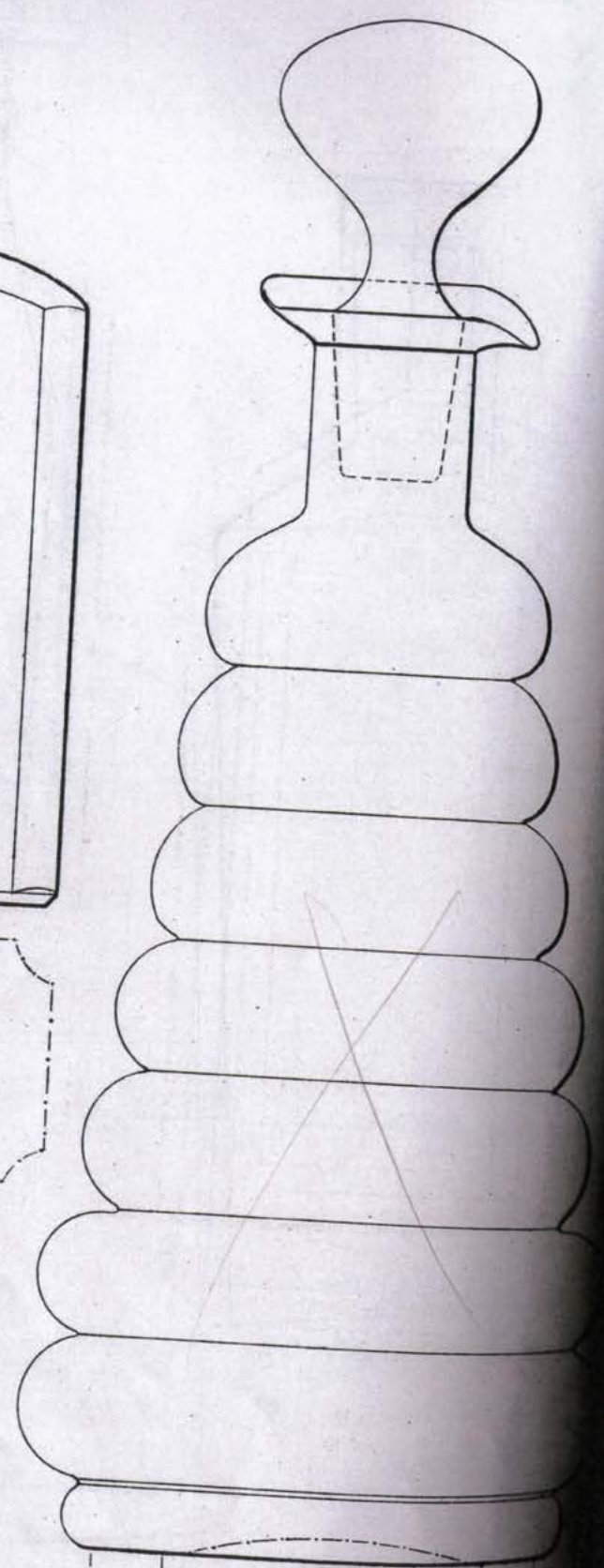

Incoperator 350 gr.

268

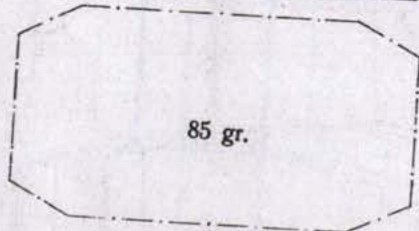
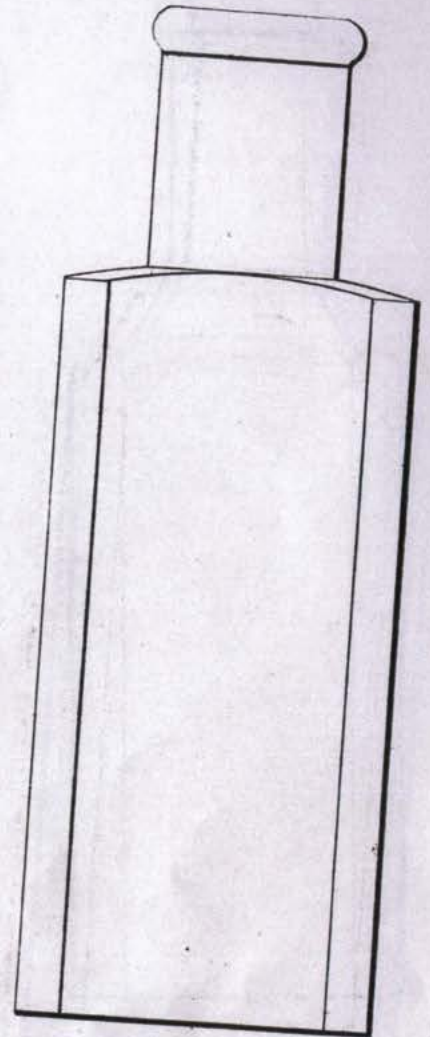
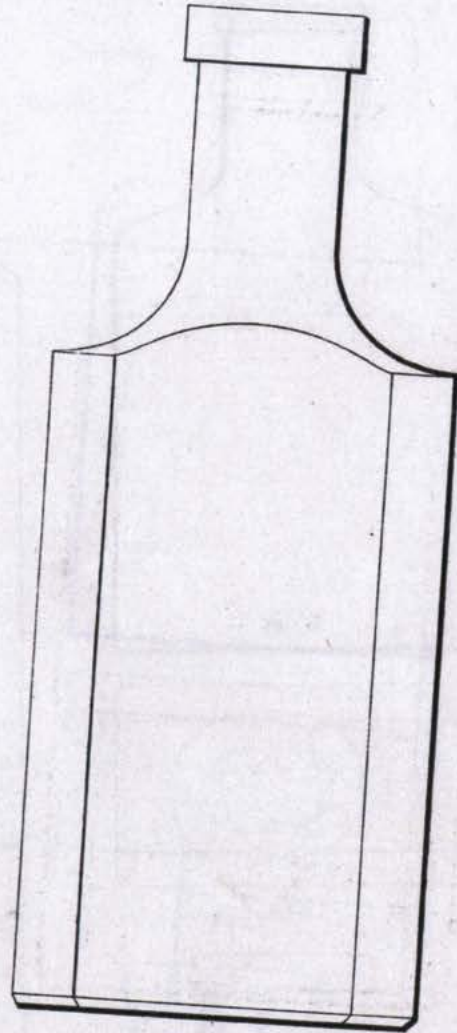
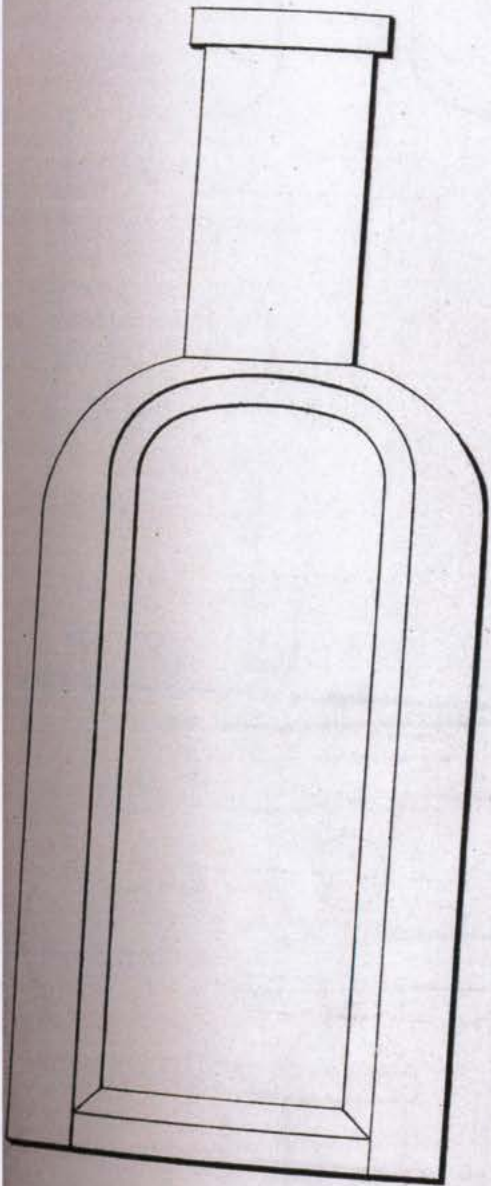

270

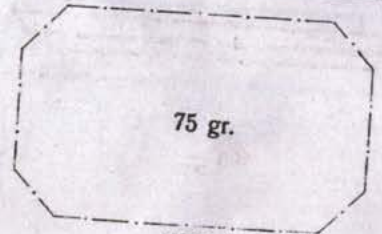

273

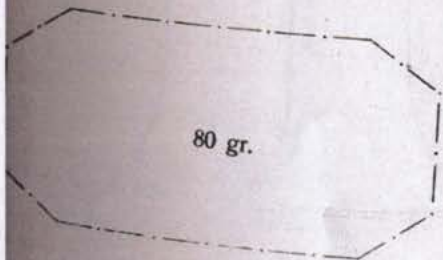

269

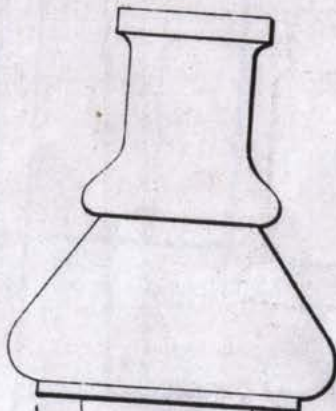

12 gr.

271

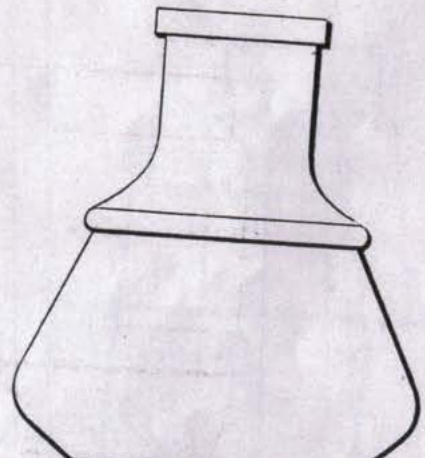

40 gr.

272

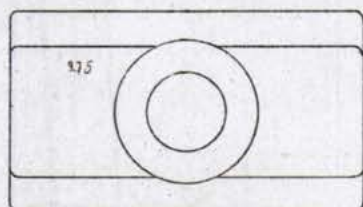
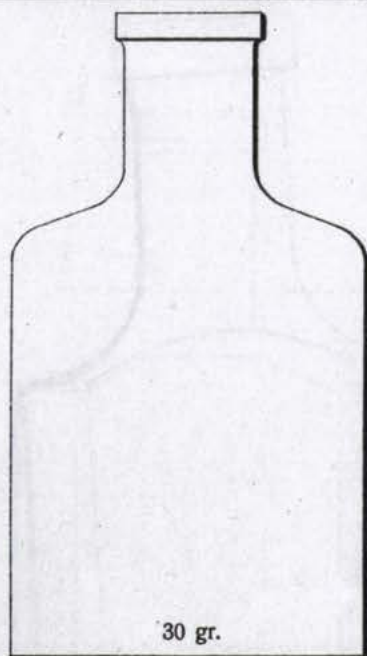
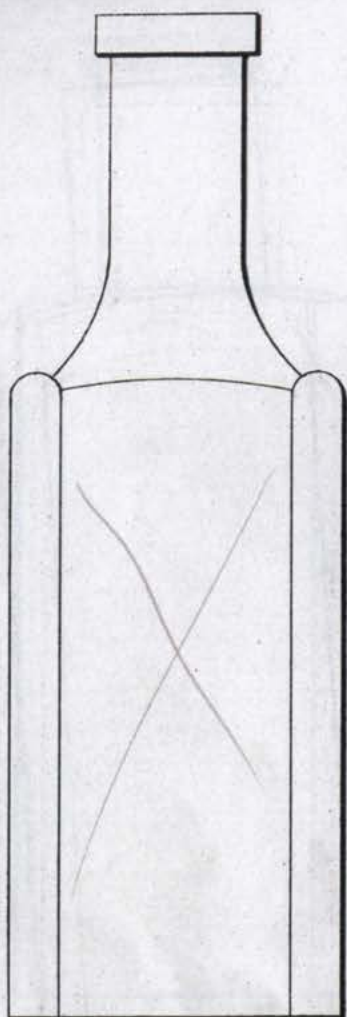

275

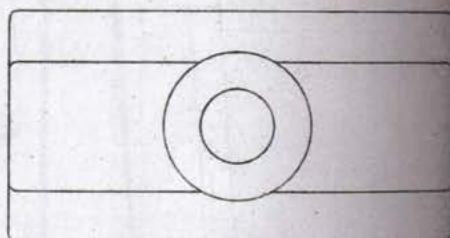
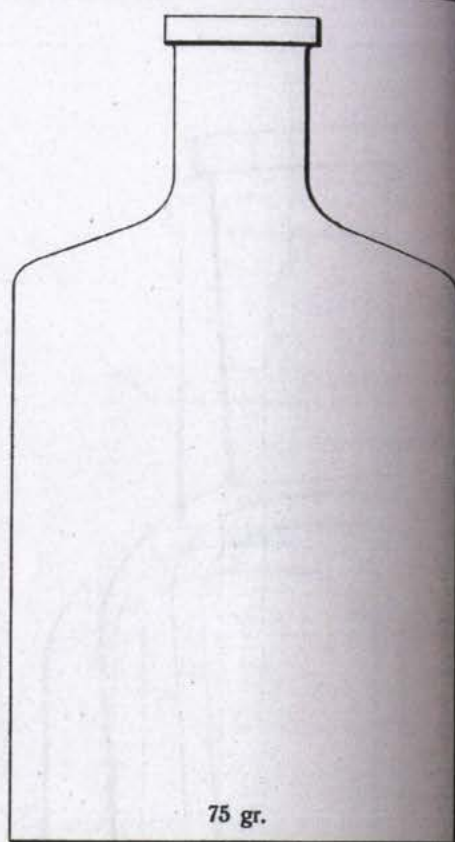

276



70 gr.

274

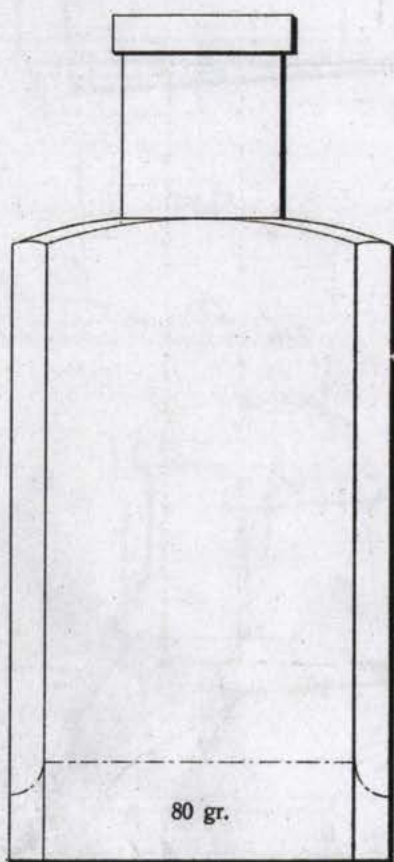

80 gr.

280

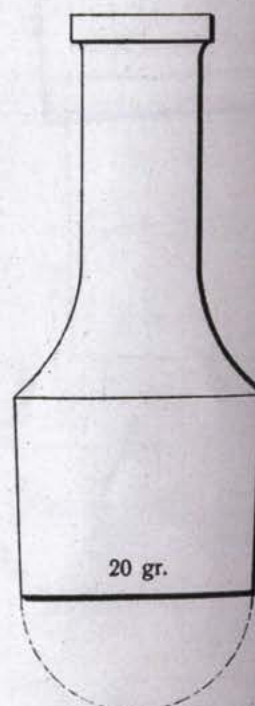

20 gr.

279

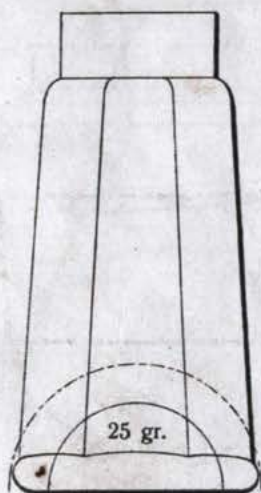

25 gr.

278

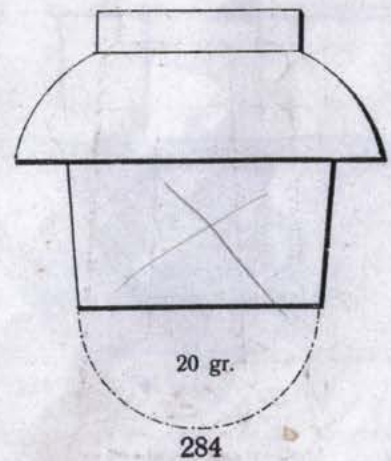
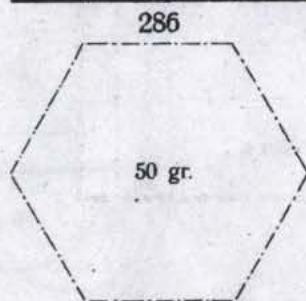
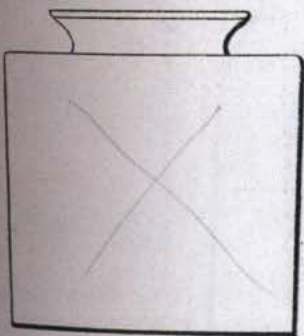
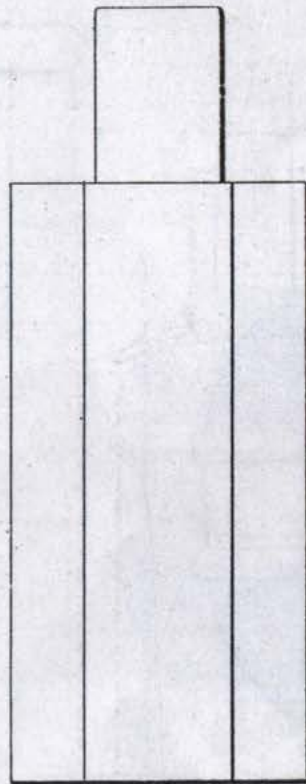
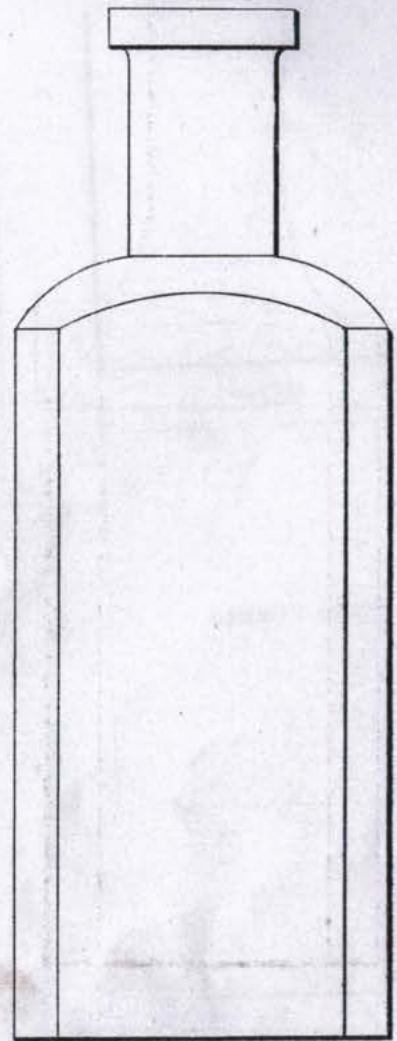
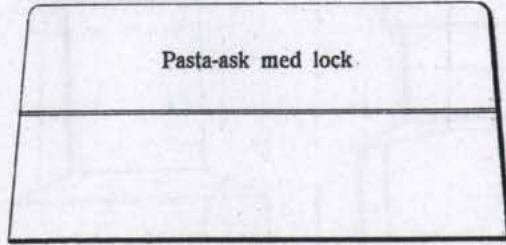
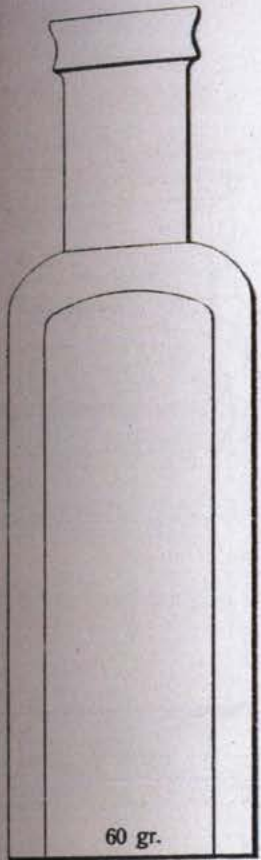

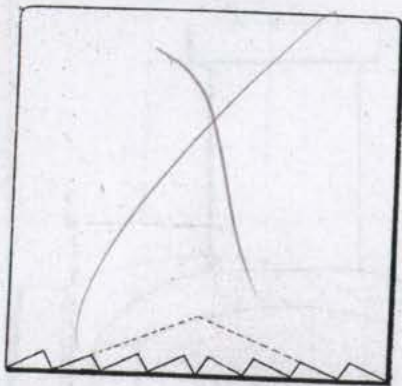

287



Stjärna i botten

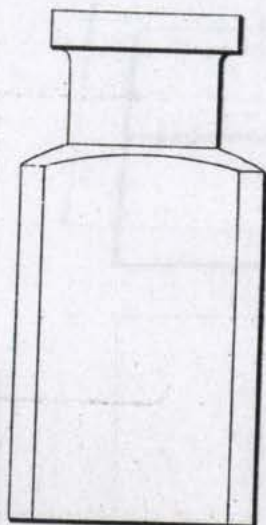

288

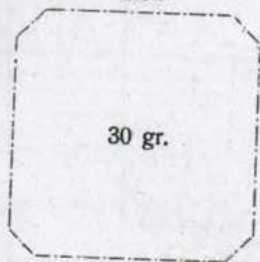

30 gr.

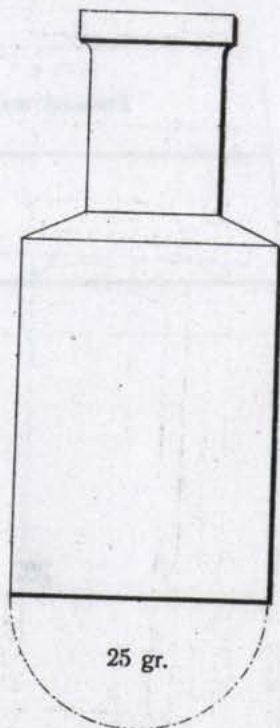

25 gr.

289

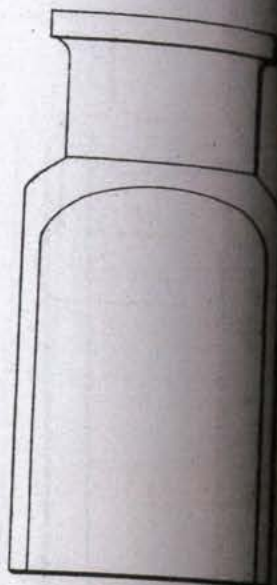

293



50 gr.

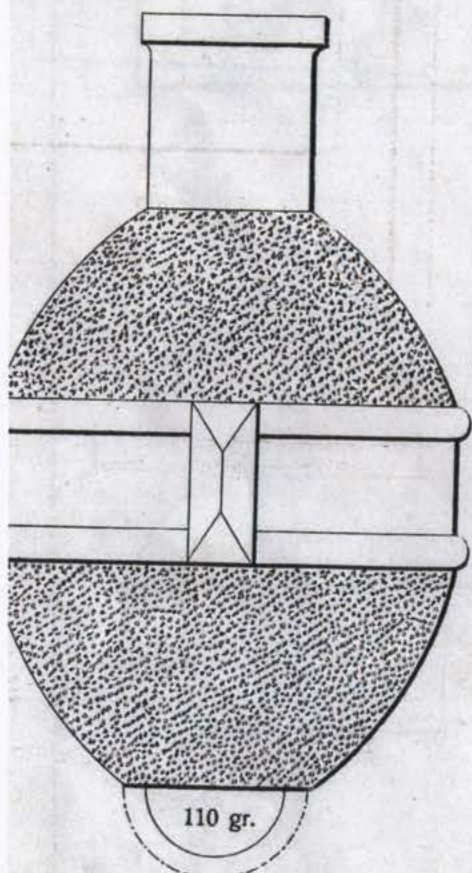

110 gr.

290

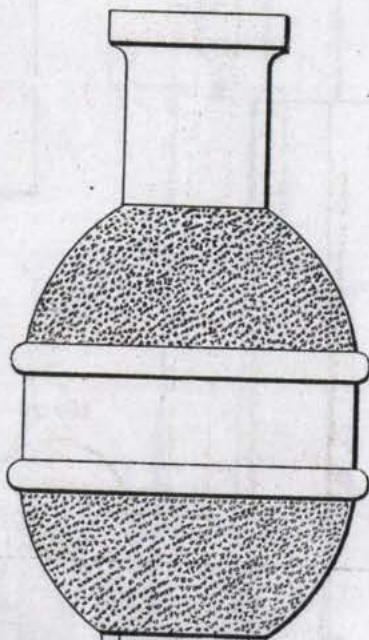

25 gr.

291

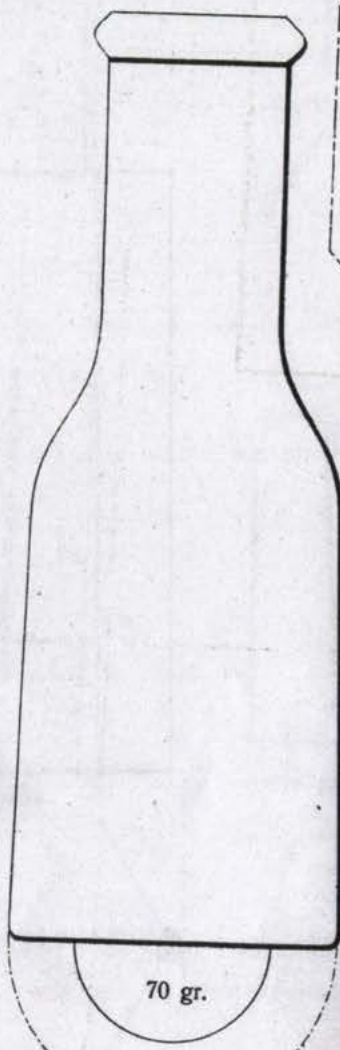

70 gr.

292

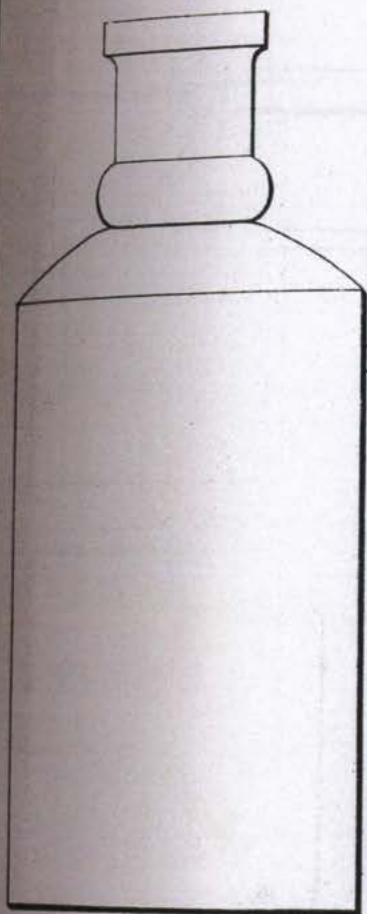

294

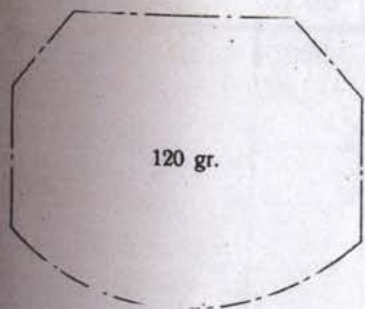

120 gr.

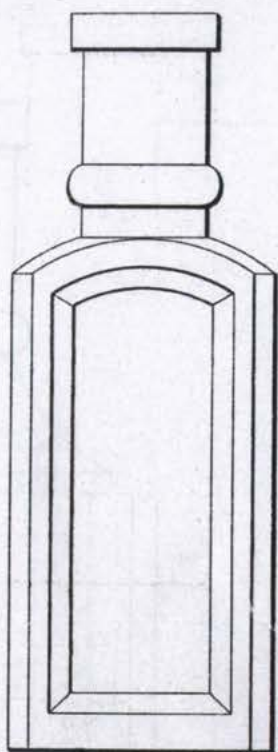

295

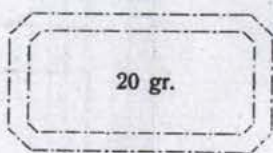

20 gr.

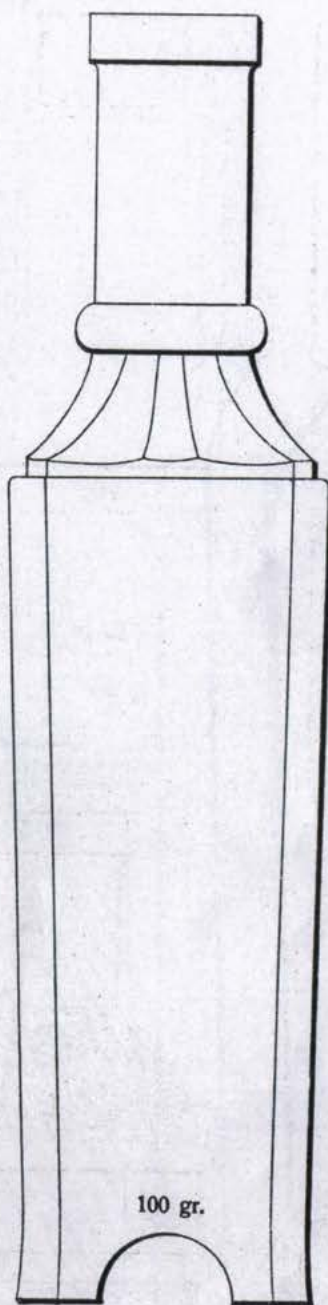

100 gr.

296

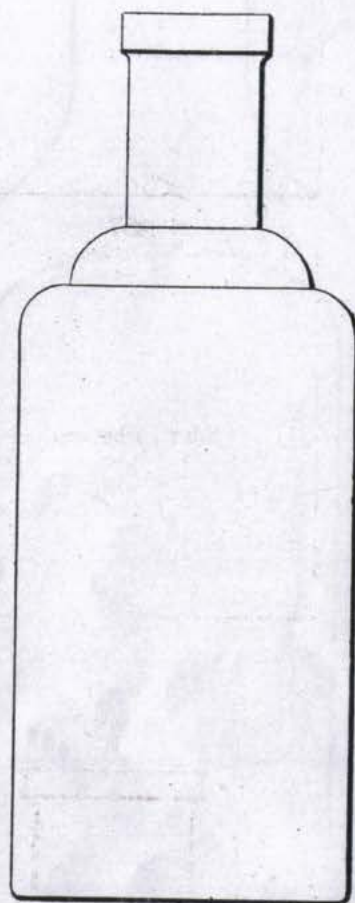
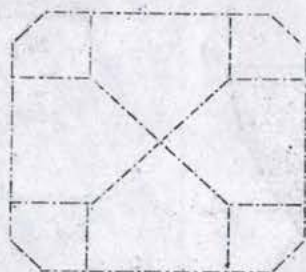

297

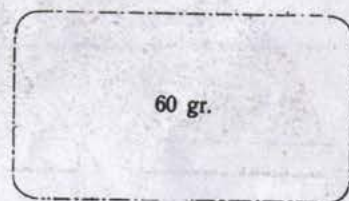

60 gr.



298

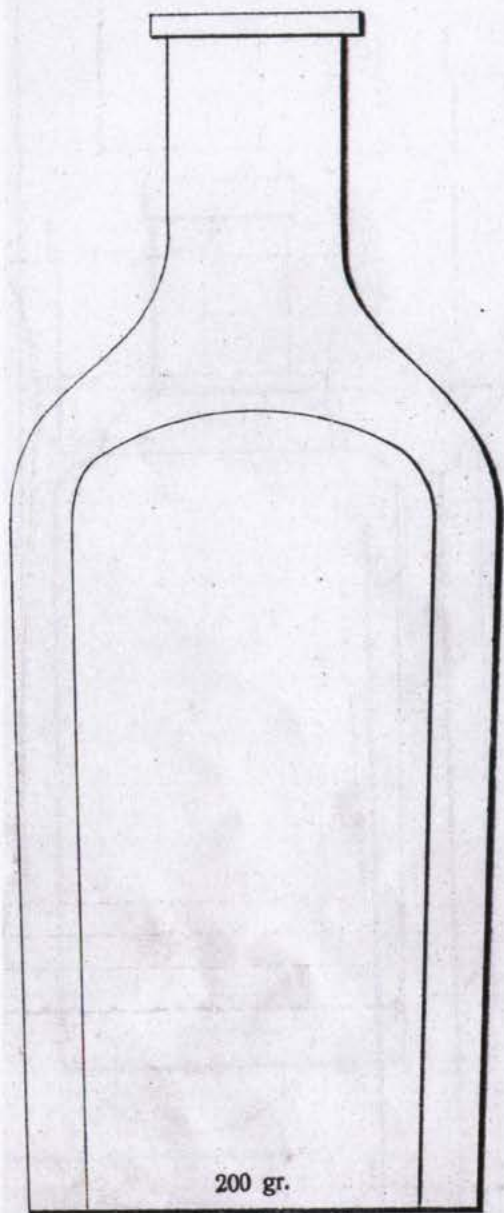

200 gr.

299

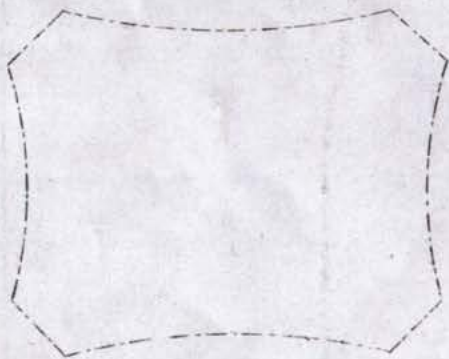

35 gr.

301

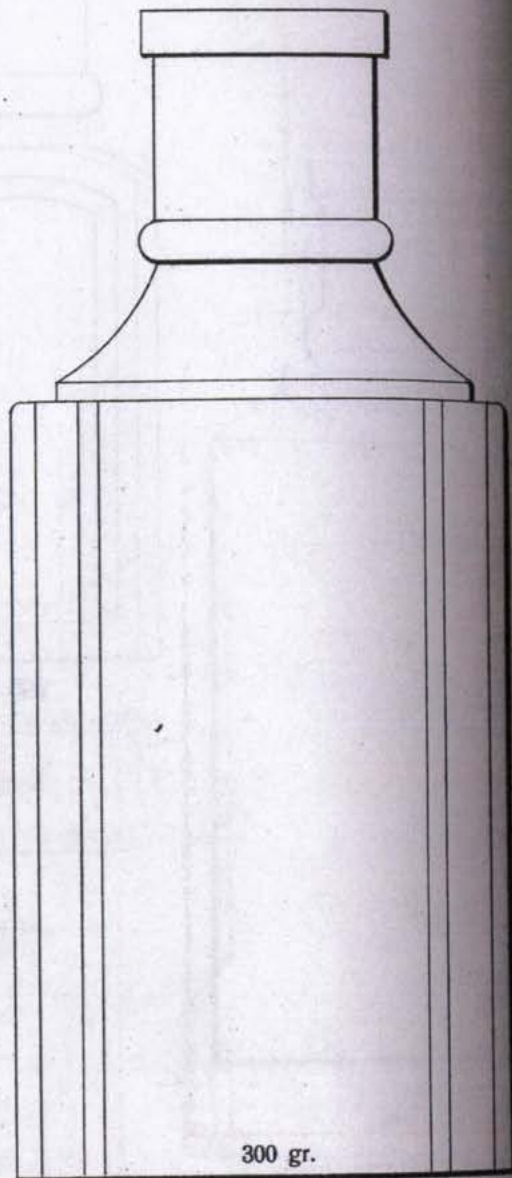

300 gr.

300



Stjärna i botten

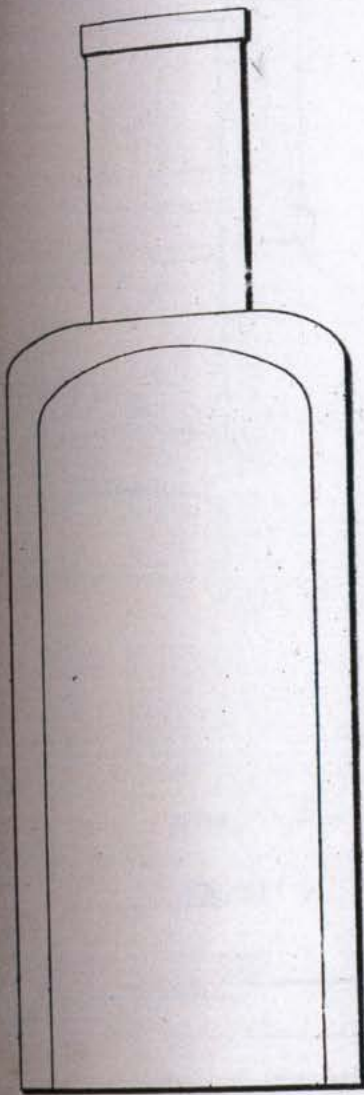

302



180 gr.

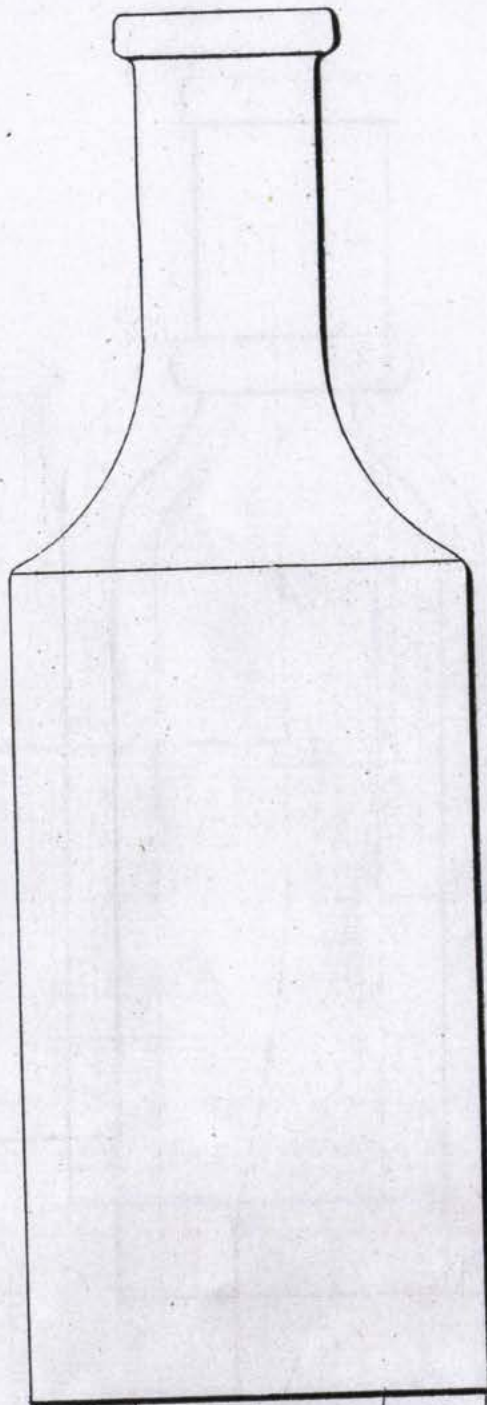

275 gr.

303

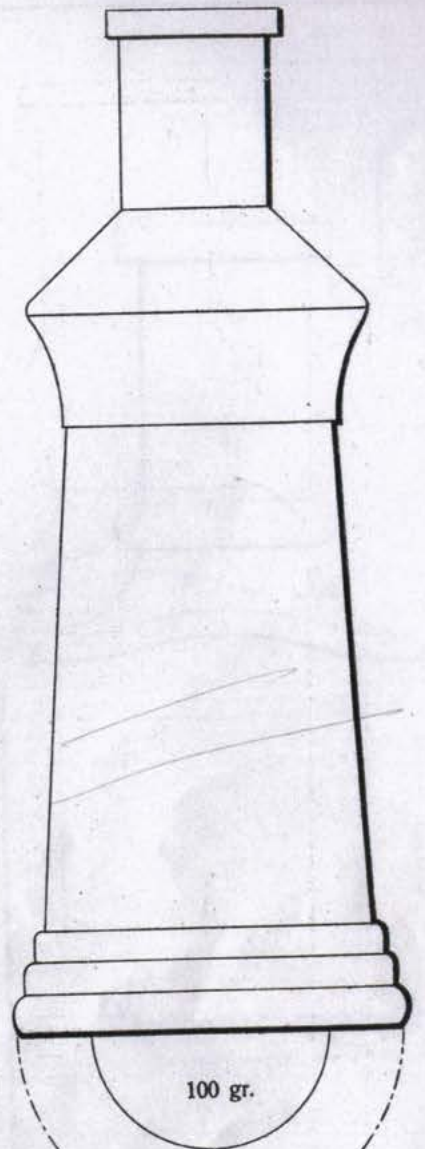

100 gr.

304



10 gr.

306

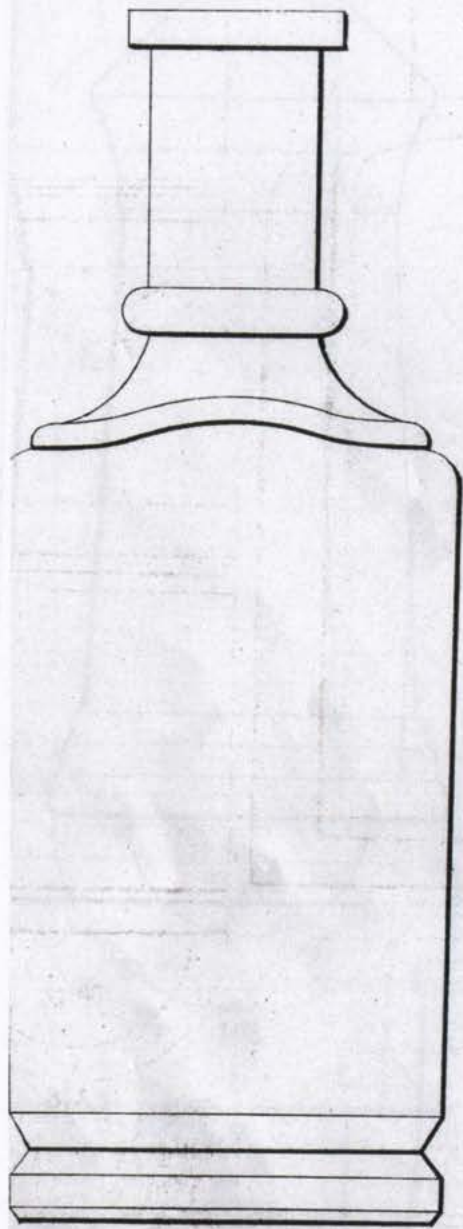

305 .



140 gr

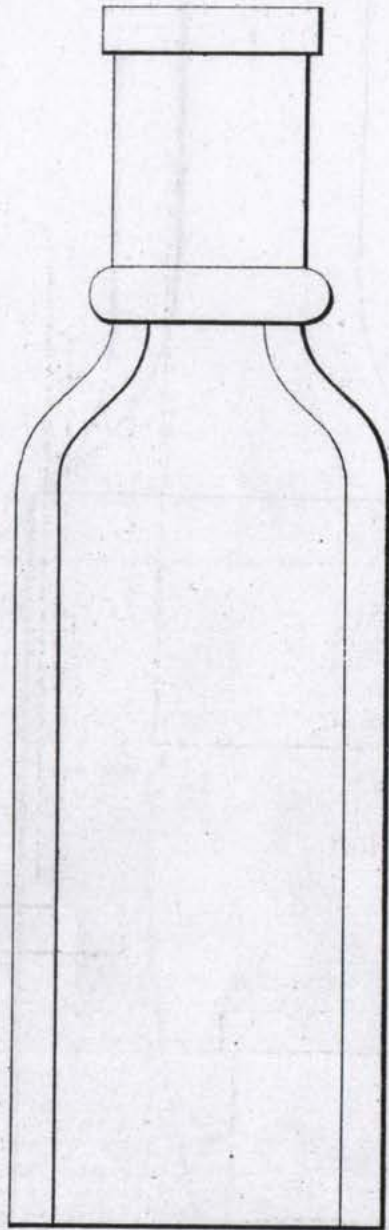

307



180 gr.



100 gr.

308



150 gr.

309

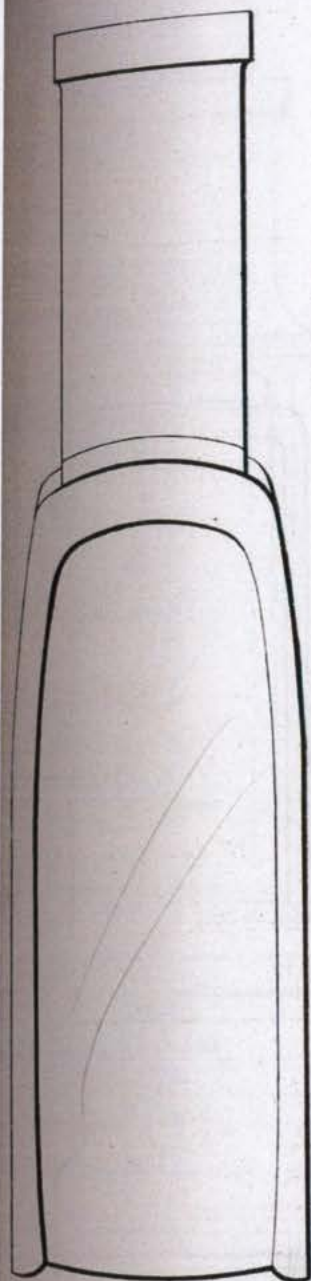

311



100 gr.

310

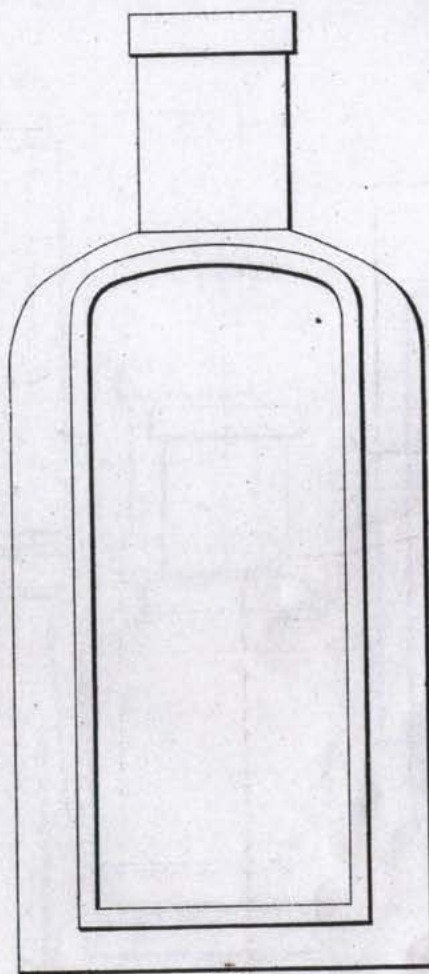

313

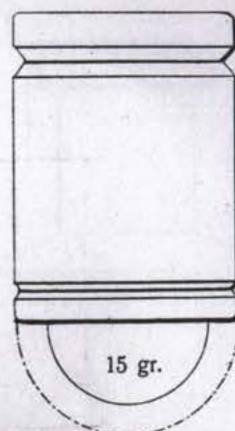

15 gr.

315

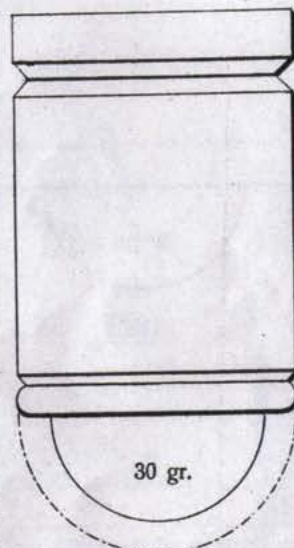

30 gr.

316

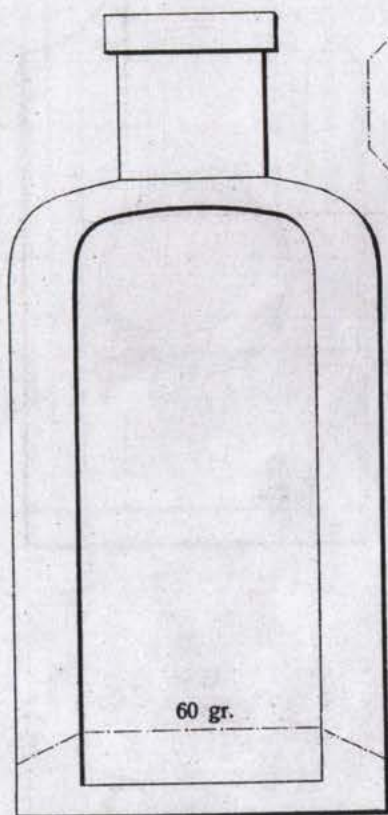

60 gr.

312

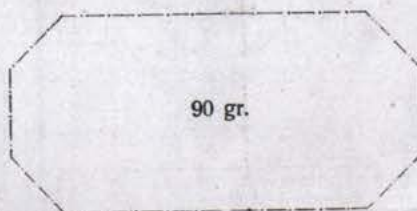

90 gr.

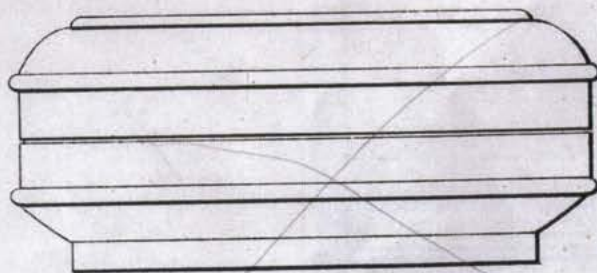

314

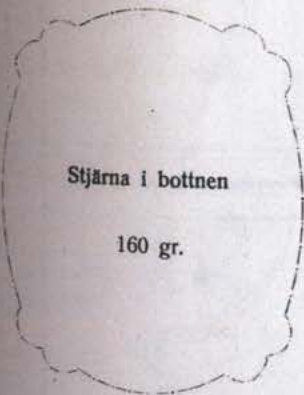

Stjärna i botten

160 gr.

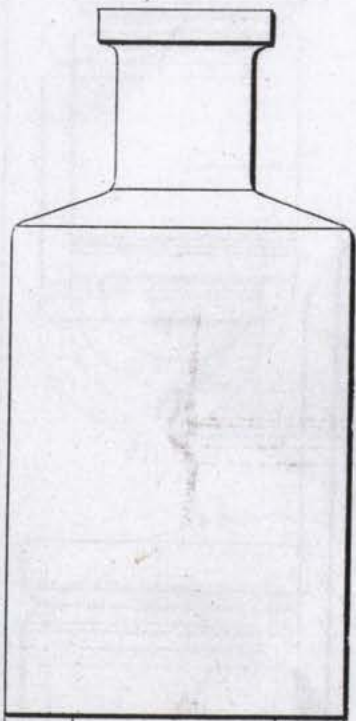

80 gr.

~~317~~

321

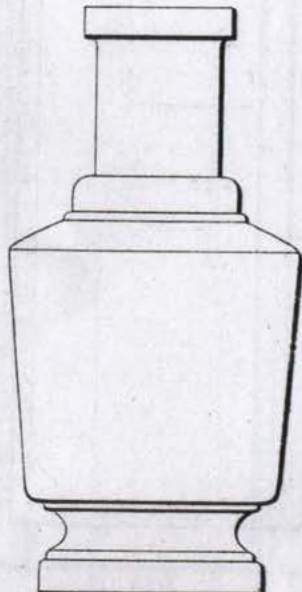

25 gr.

~~318~~

322

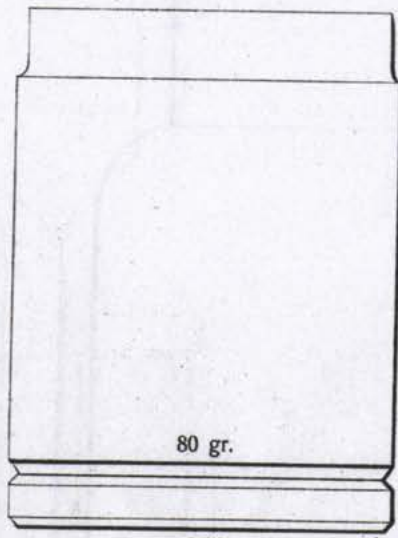

80 gr.

~~323~~

320

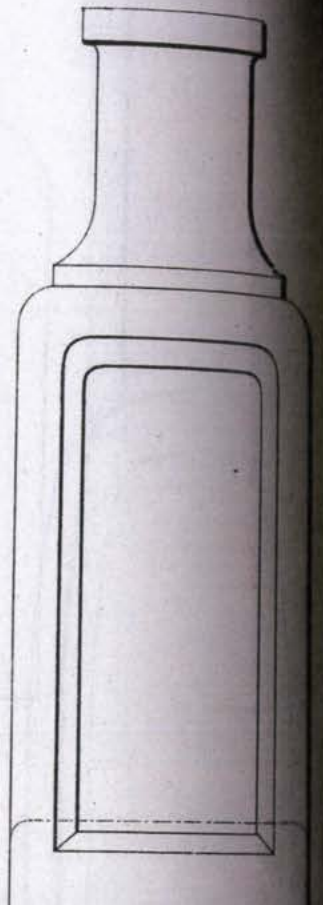

65 gr.

~~320~~

328

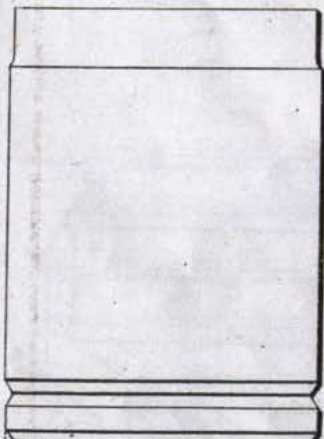

45 gr.

~~321~~

318

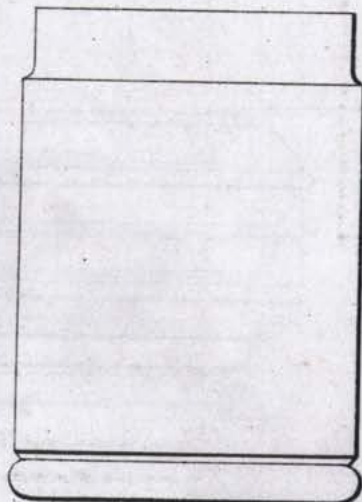

60 gr.

~~322~~

319

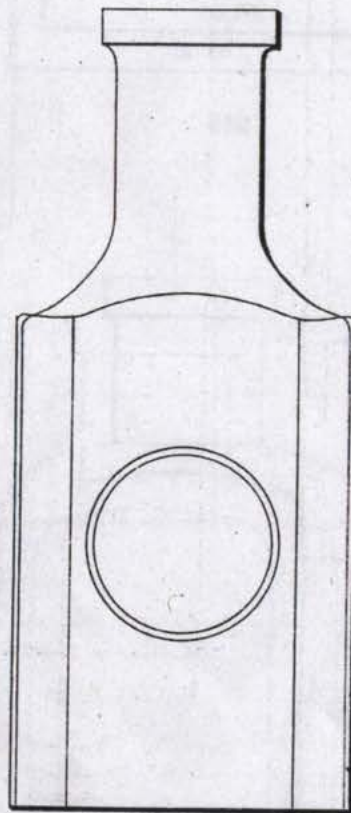

45 gr.

324



35 gr.

~~319~~

317

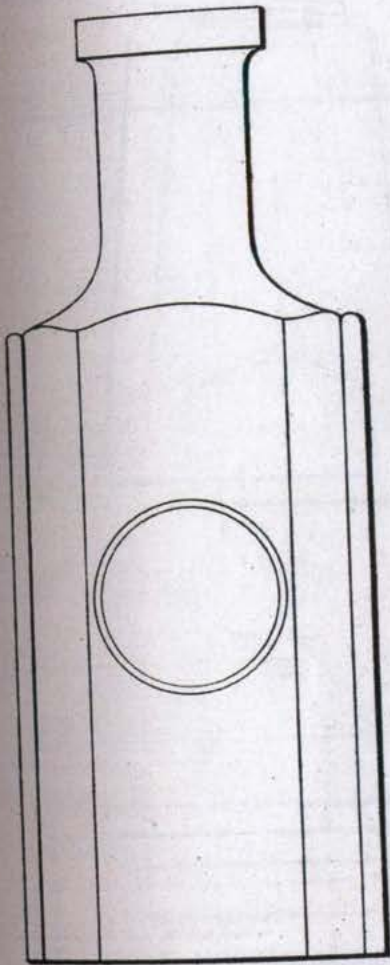

65 gr.

325



60 gr.

326

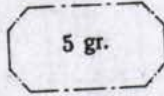
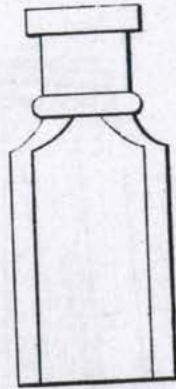

5 gr.

327

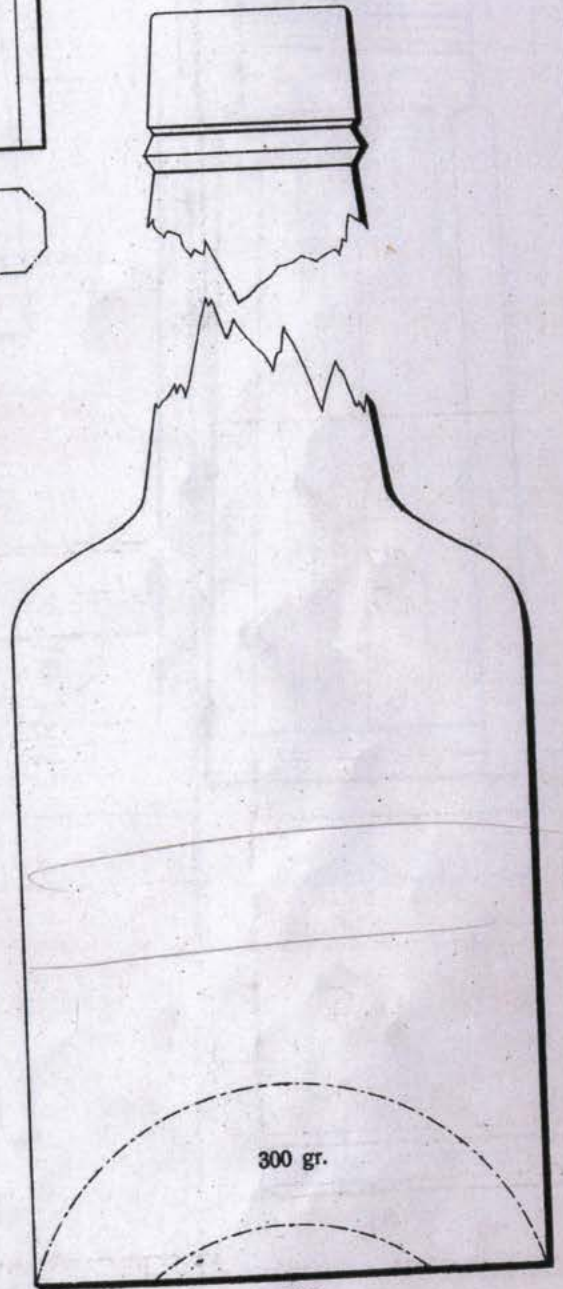

300 gr.

329

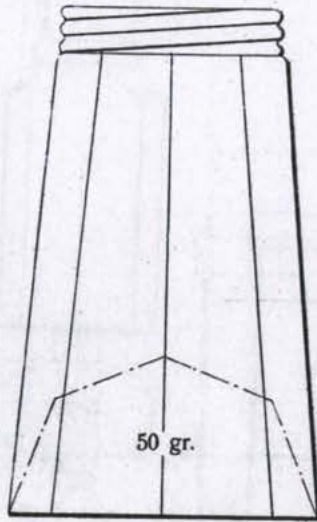

331

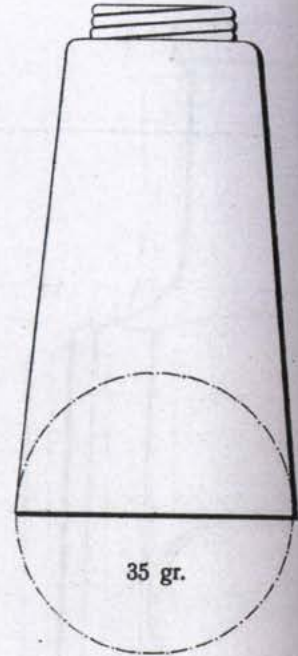

333

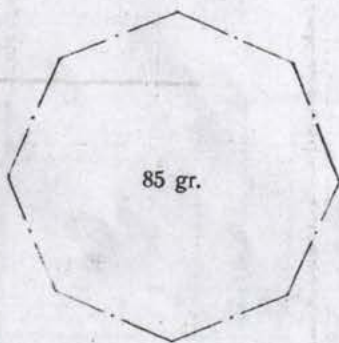

330

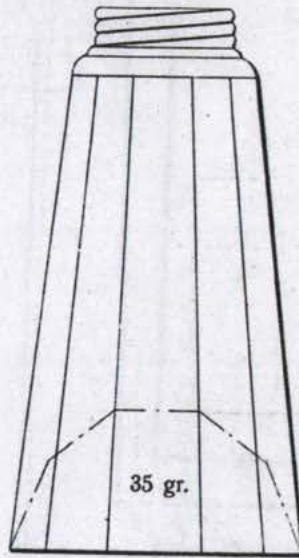

332

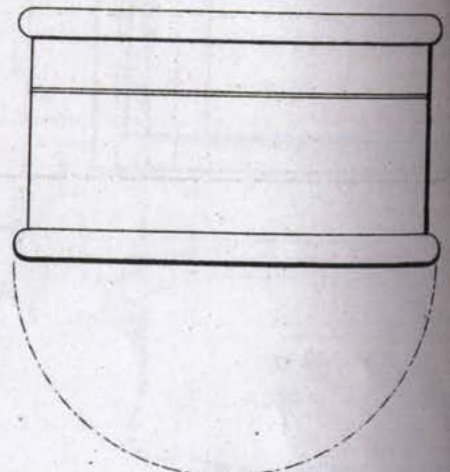

334

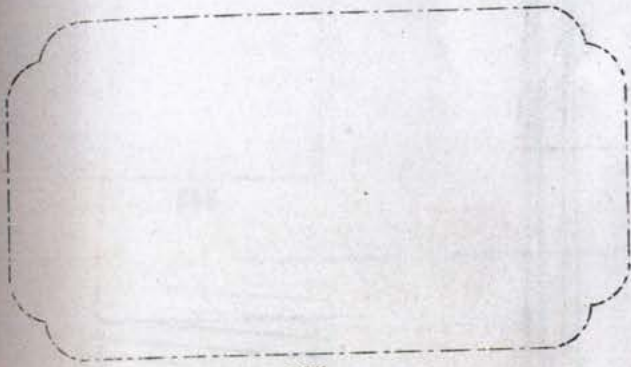
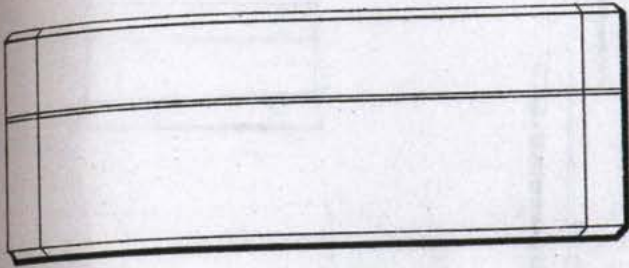

335

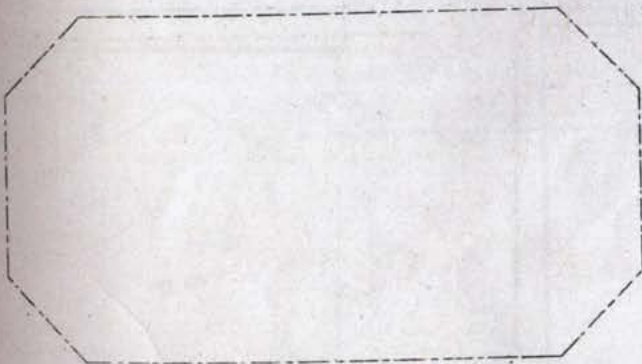
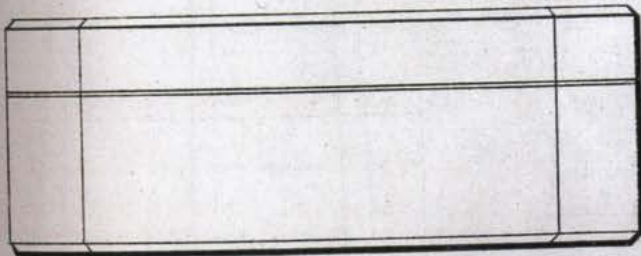

336

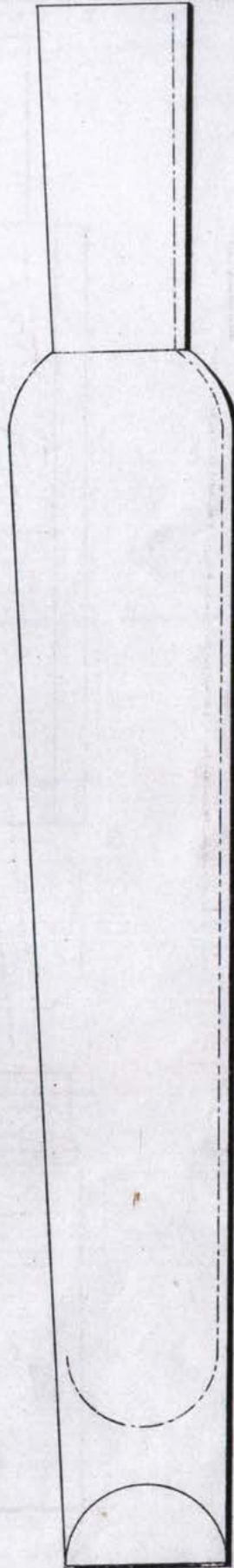

337

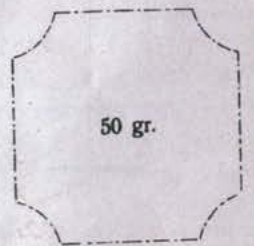
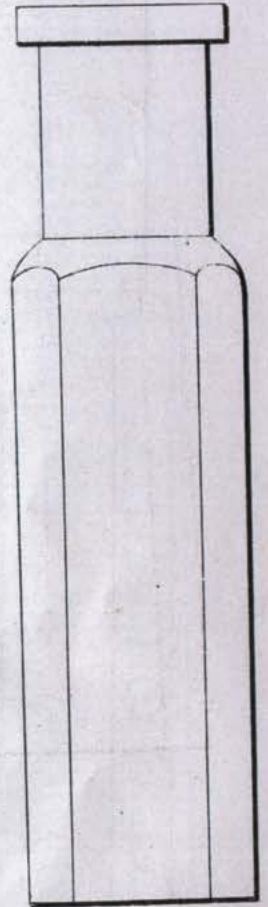

50 gr.

338

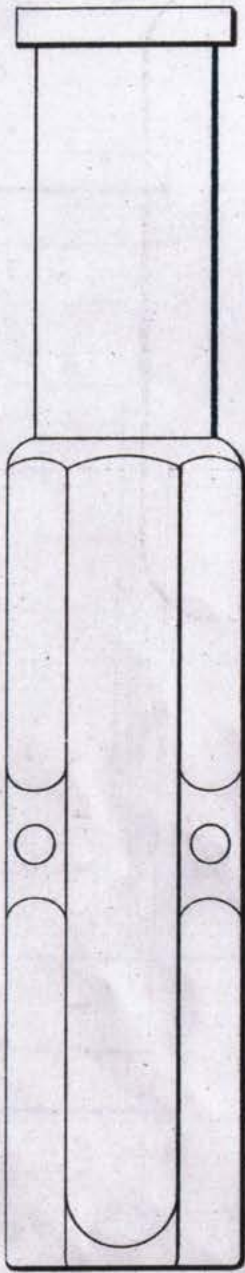

339

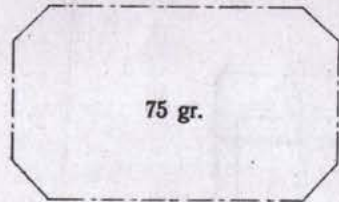
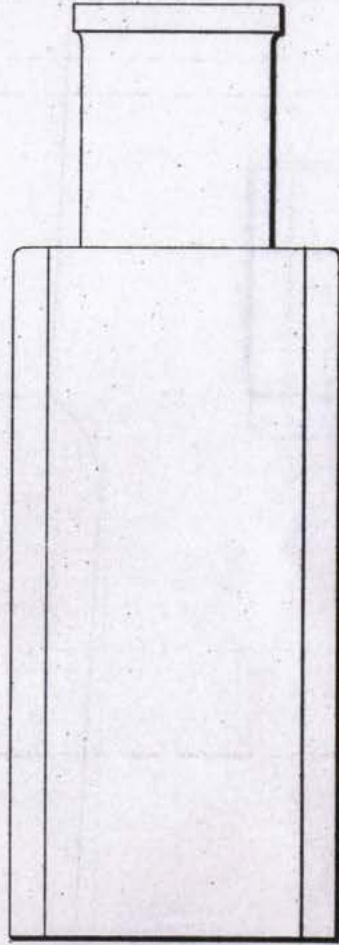

340

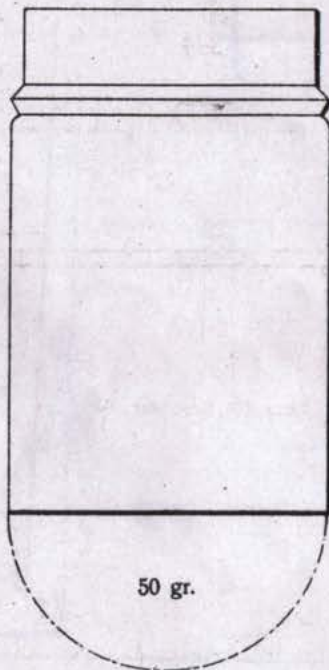

50 gr.

341

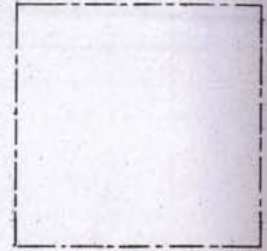
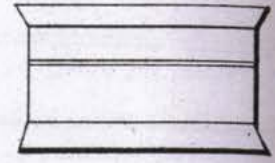

342

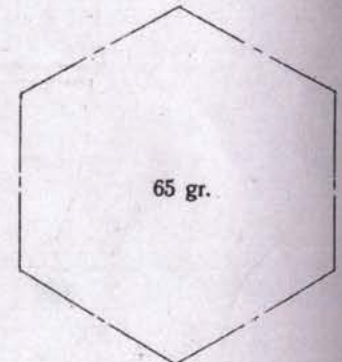
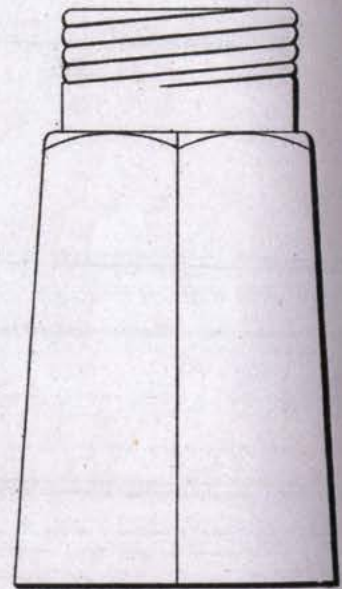

65 gr.

343

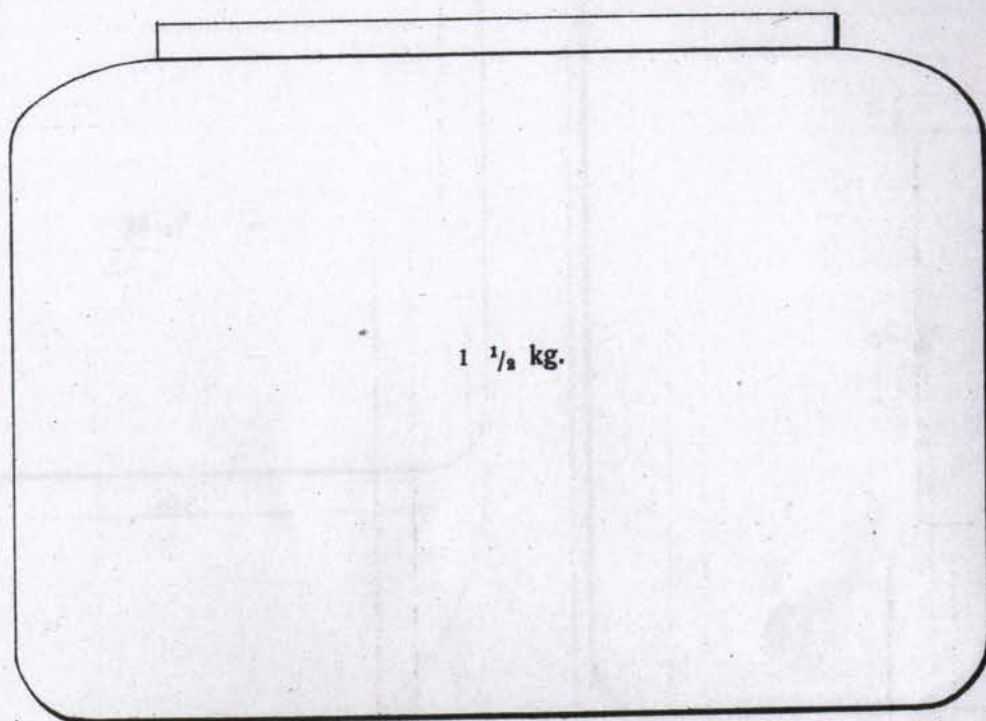

1 1/2 kg.

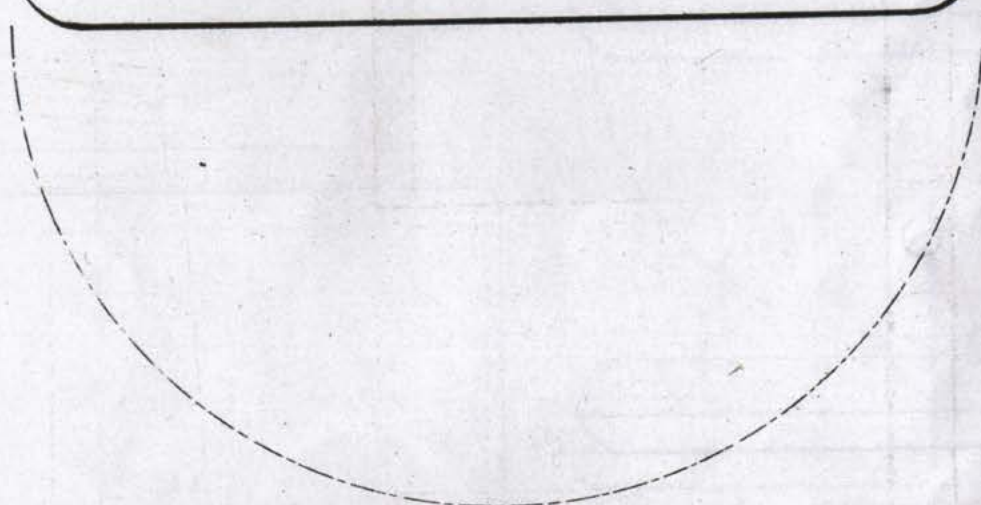

344

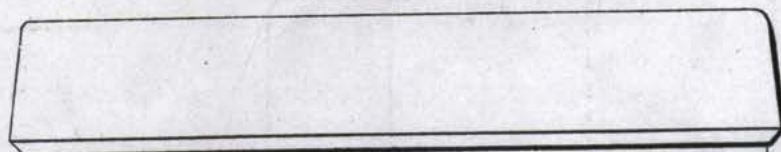

Lock till konservburk

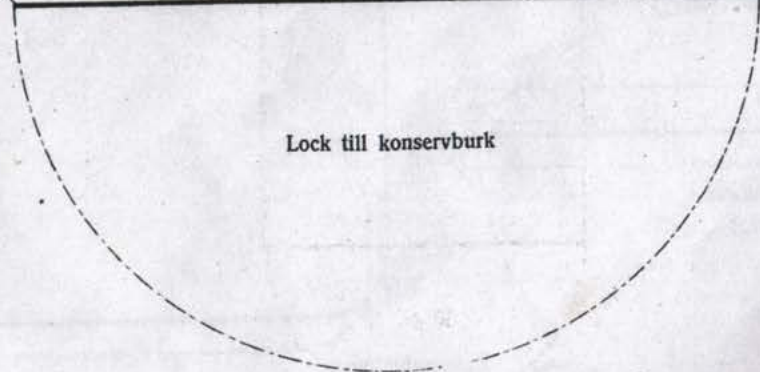

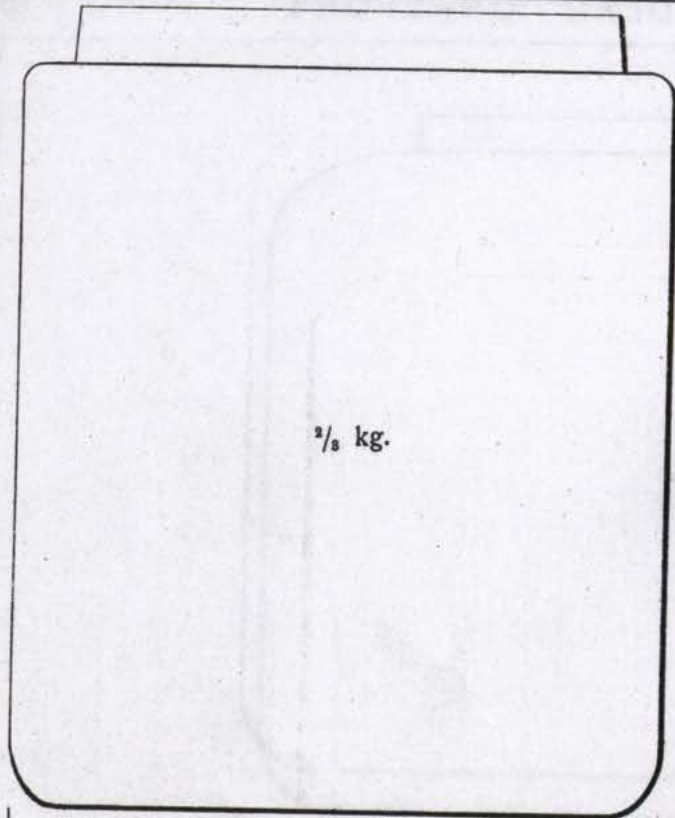

1/3 kg.

345

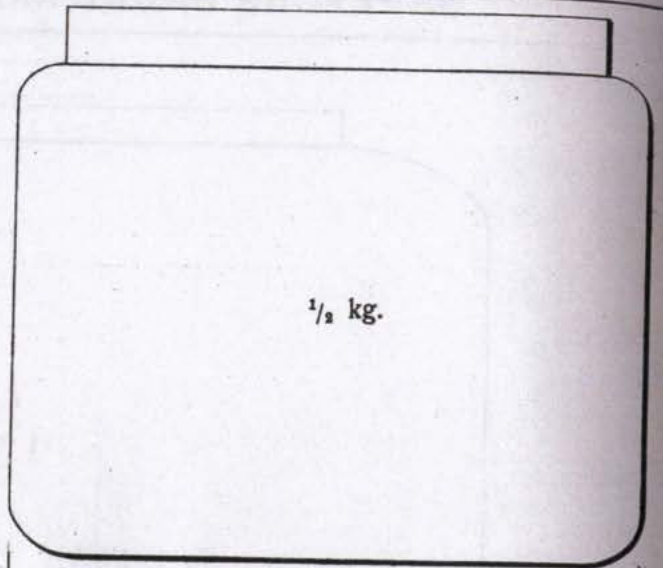

1/2 kg.

346



Lock till konservburk

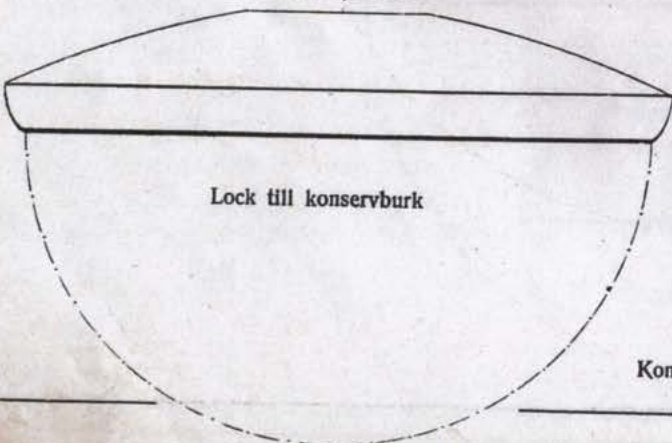

Lock till konservburk

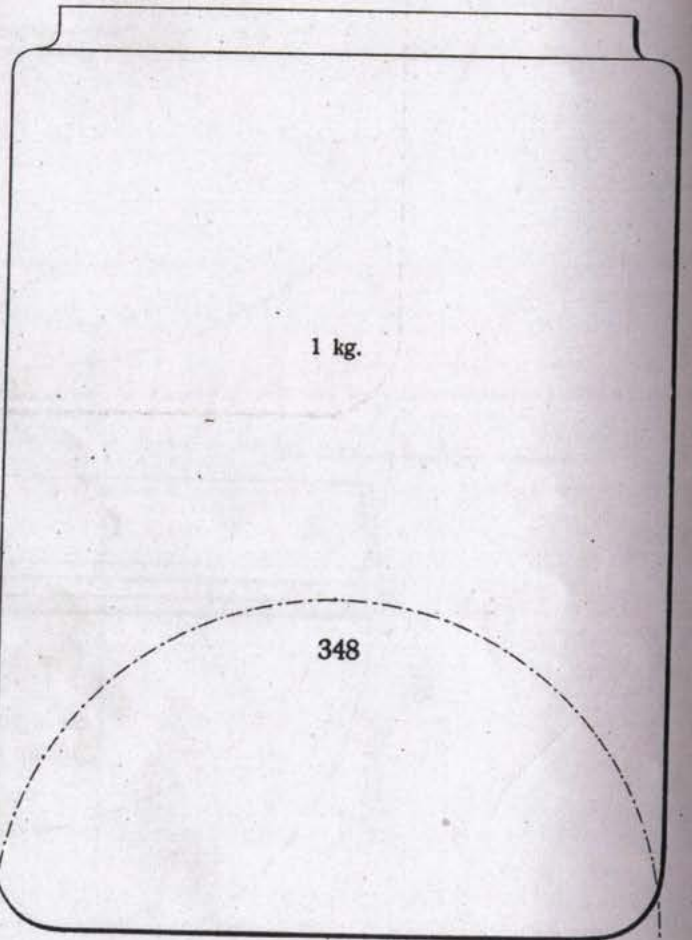

1 kg.

348

Konservburkar

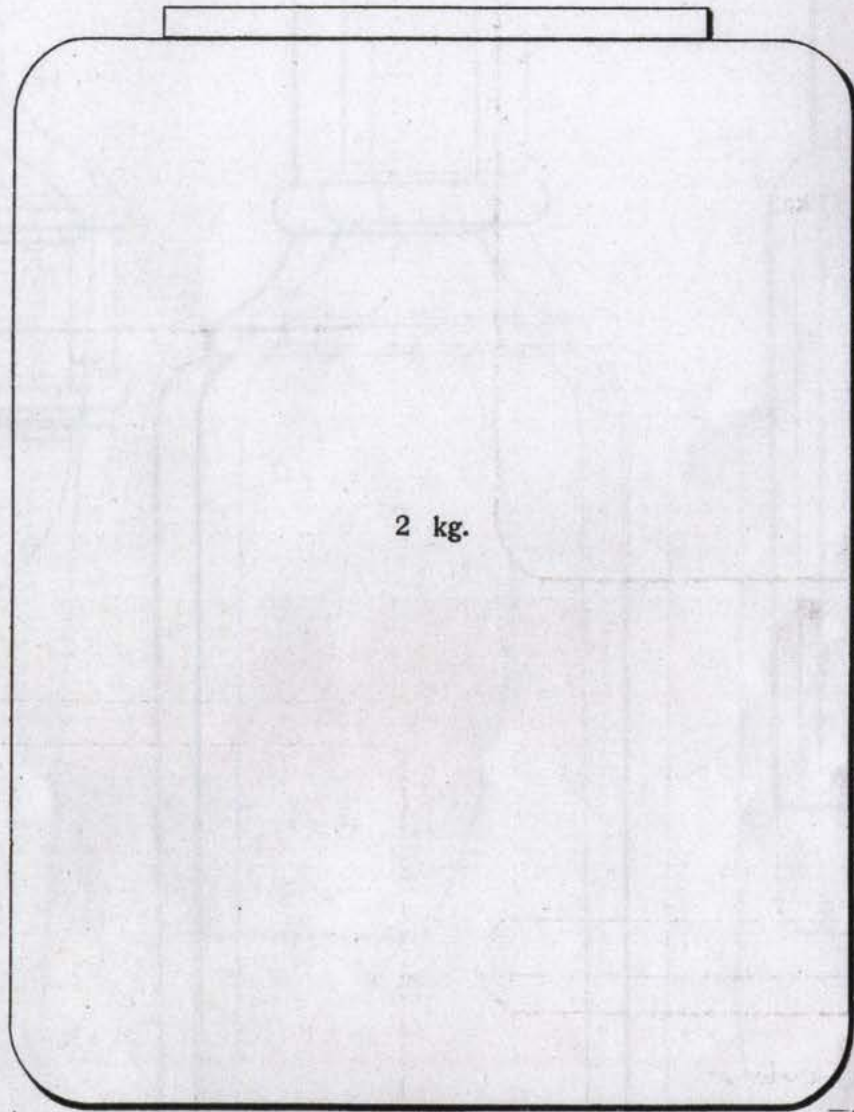

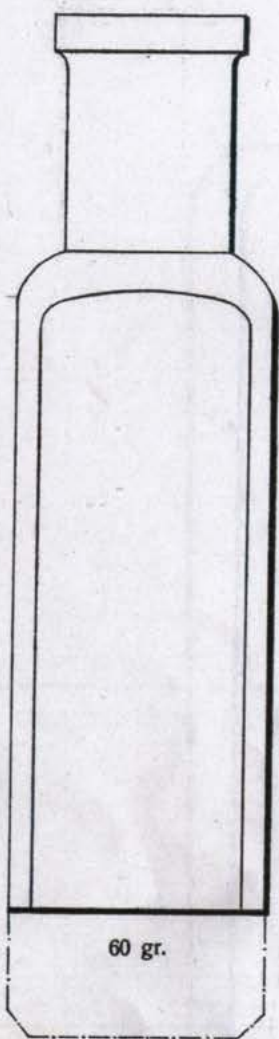

60 gr.

350

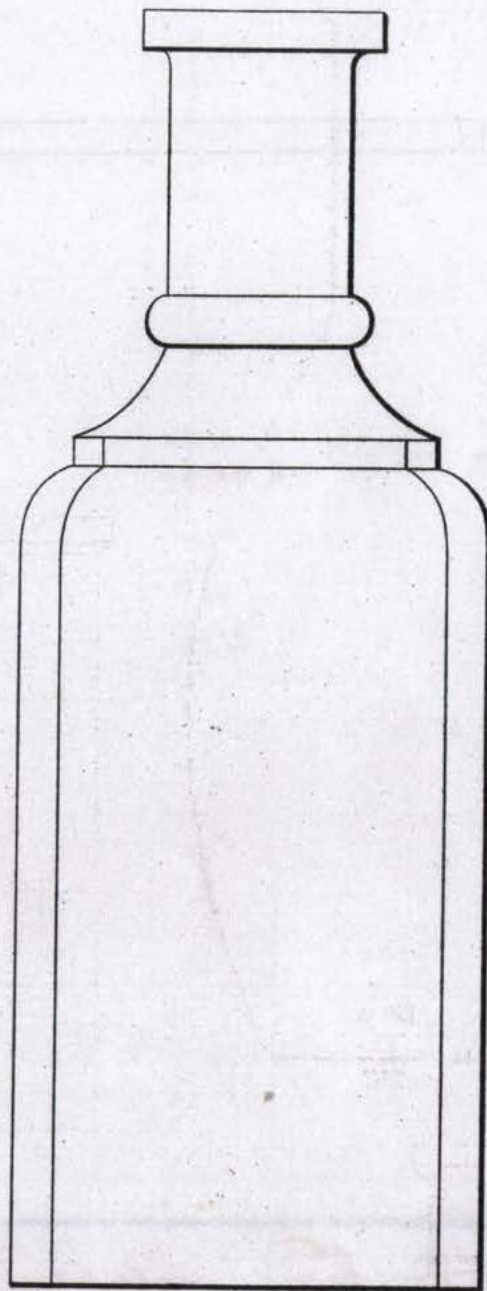

250 gr.

352

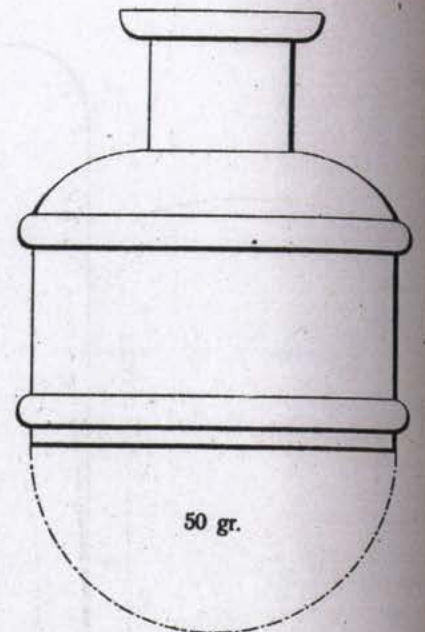

50 gr.

353



20 gr.

351

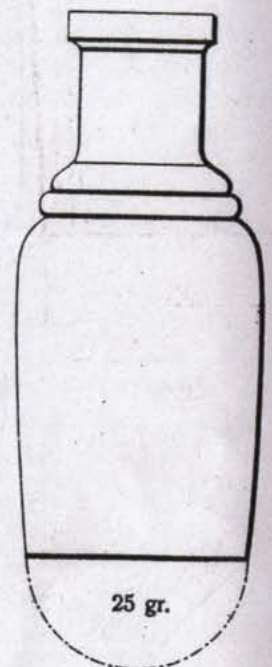

25 gr.

354

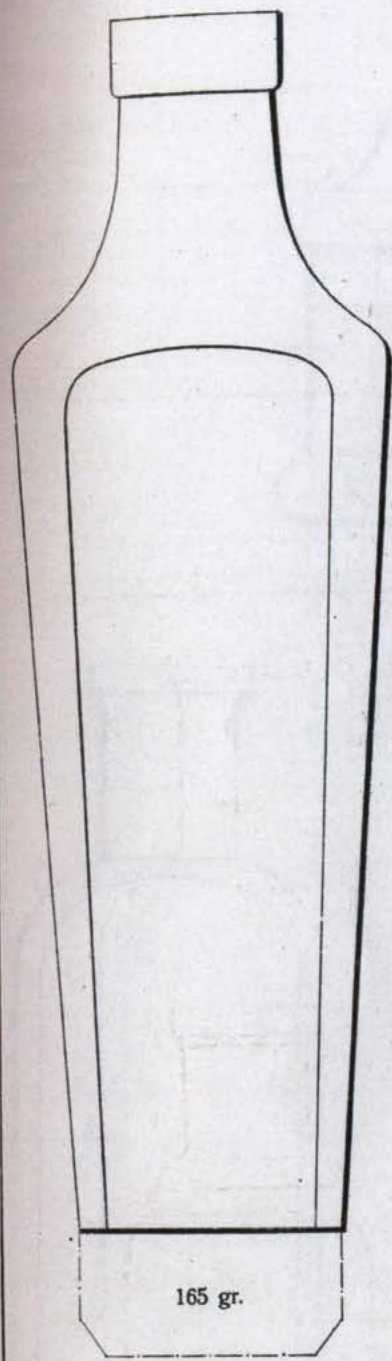

165 gr.

356

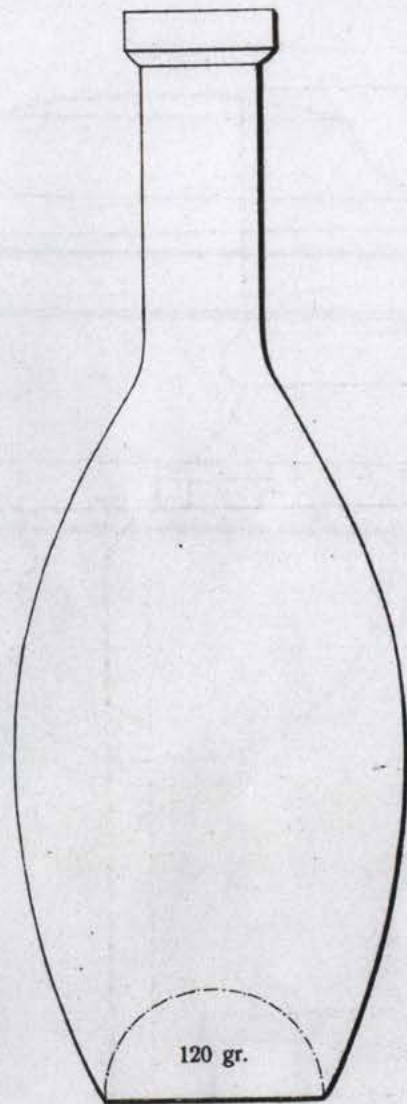

120 gr.

357

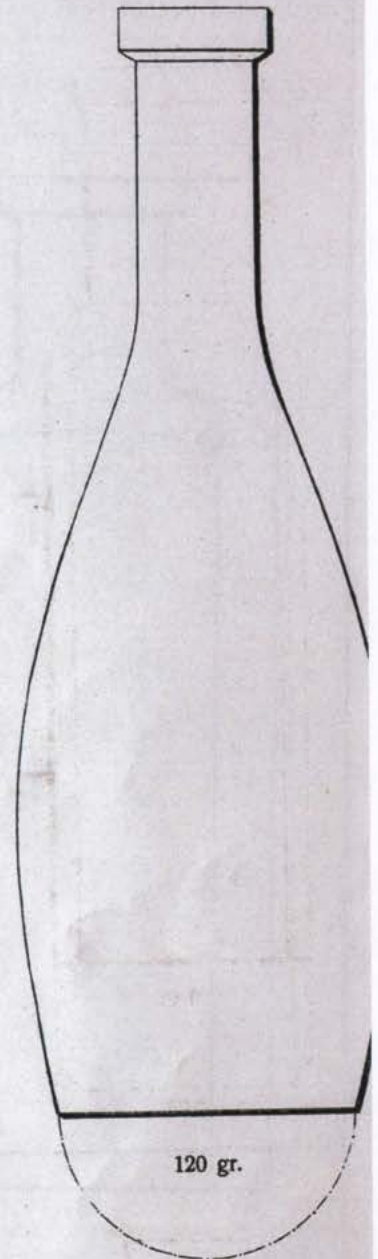

120 gr.

359

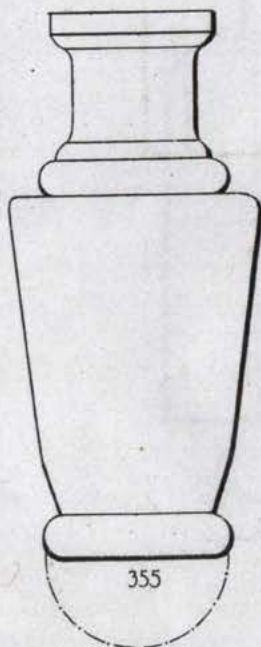

355

355

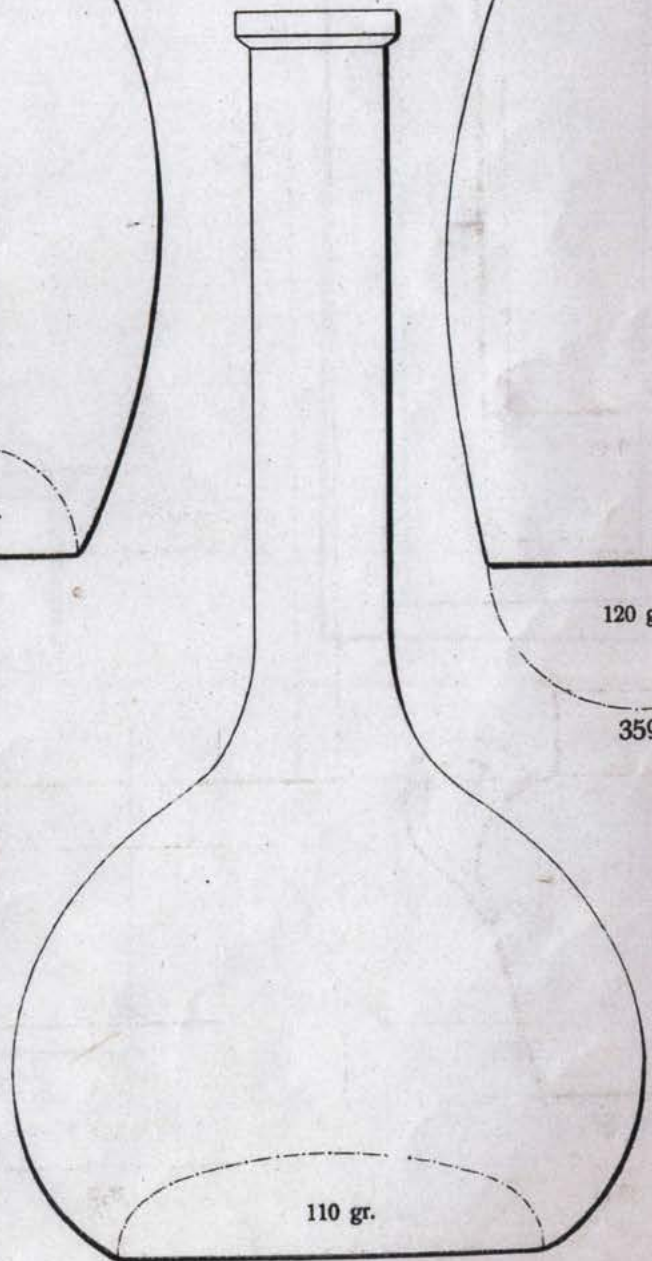

110 gr.

358

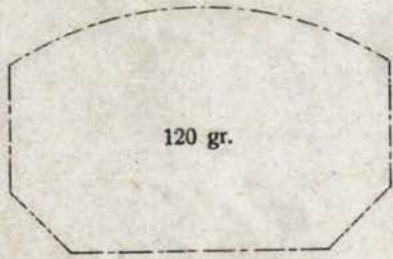

120 gr.

361

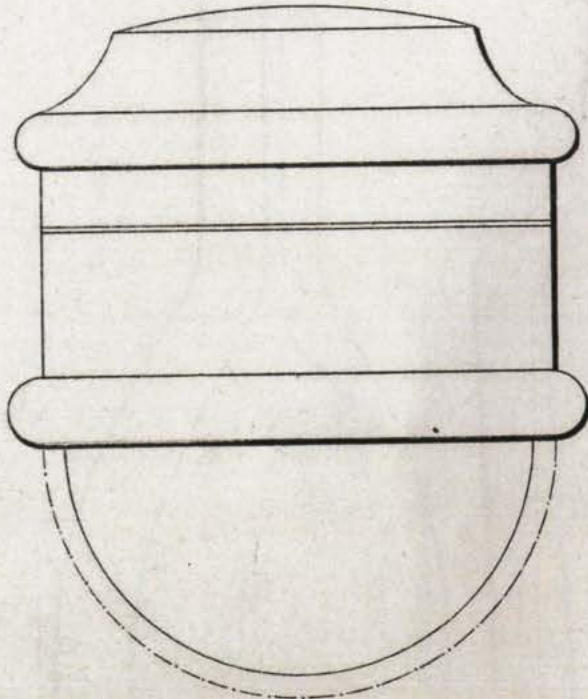

362

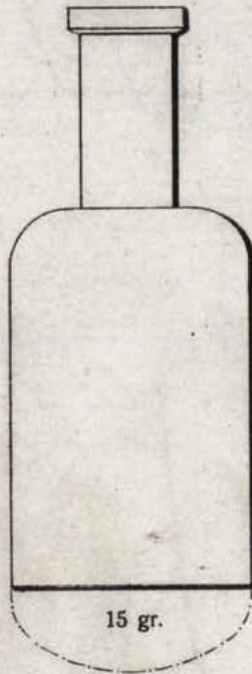

15 gr.

364

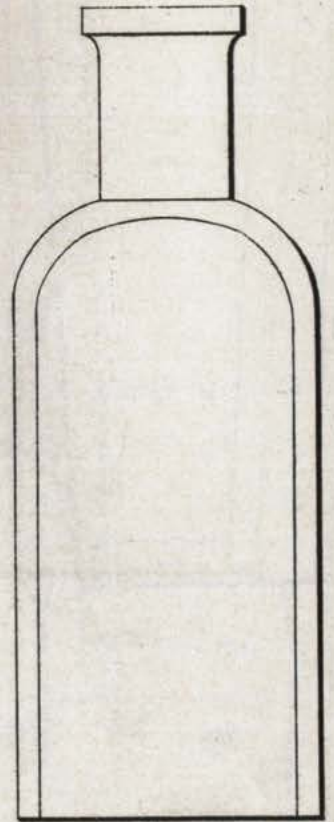

45 gr.

363